

Forme · Formes · Shapes · Formen · Formas

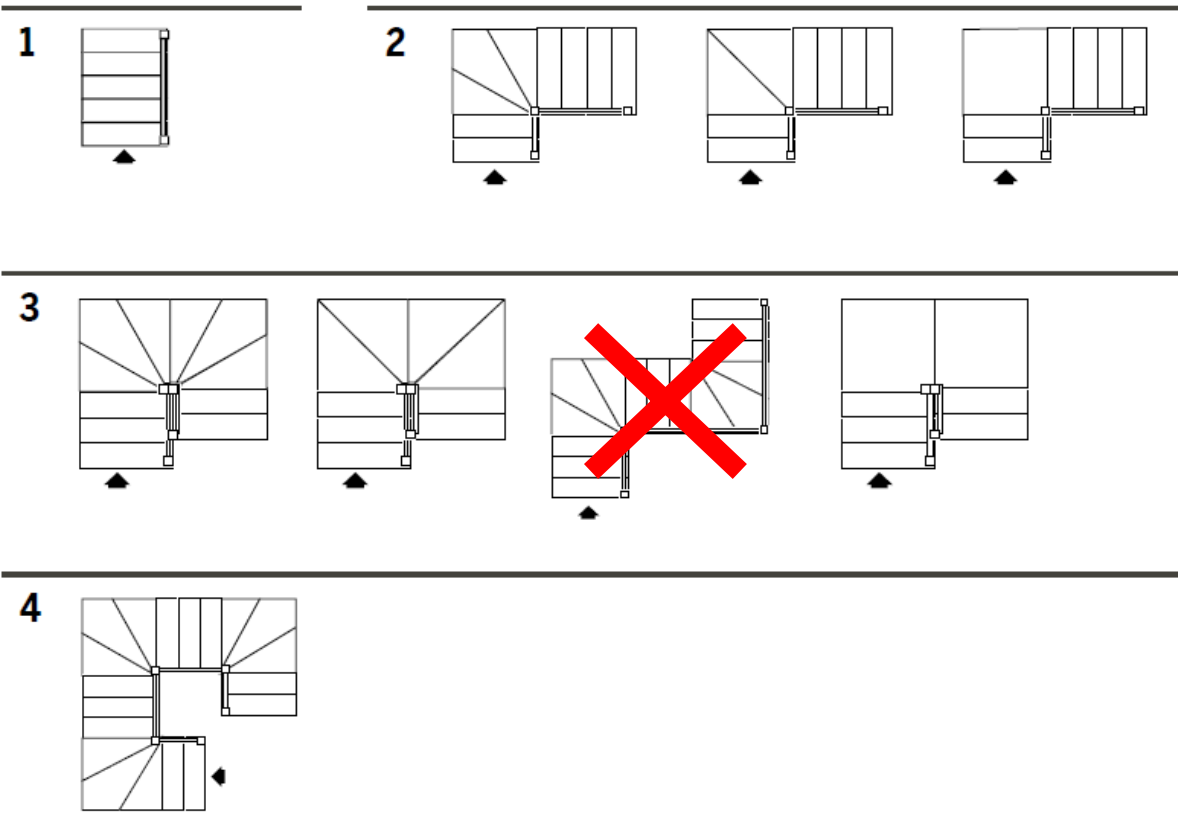

	G10	G11	G12	G13	G14	G15	G16	G17
h	1870	2040	2210	2380	2550	2720	2890	3060
G1	2310	2520	2730	2940	3150	3360	3570	3780



Caratteristiche tecniche

Technical specifications
 Spécifications techniques
 Technische Daten
 Características técnicas

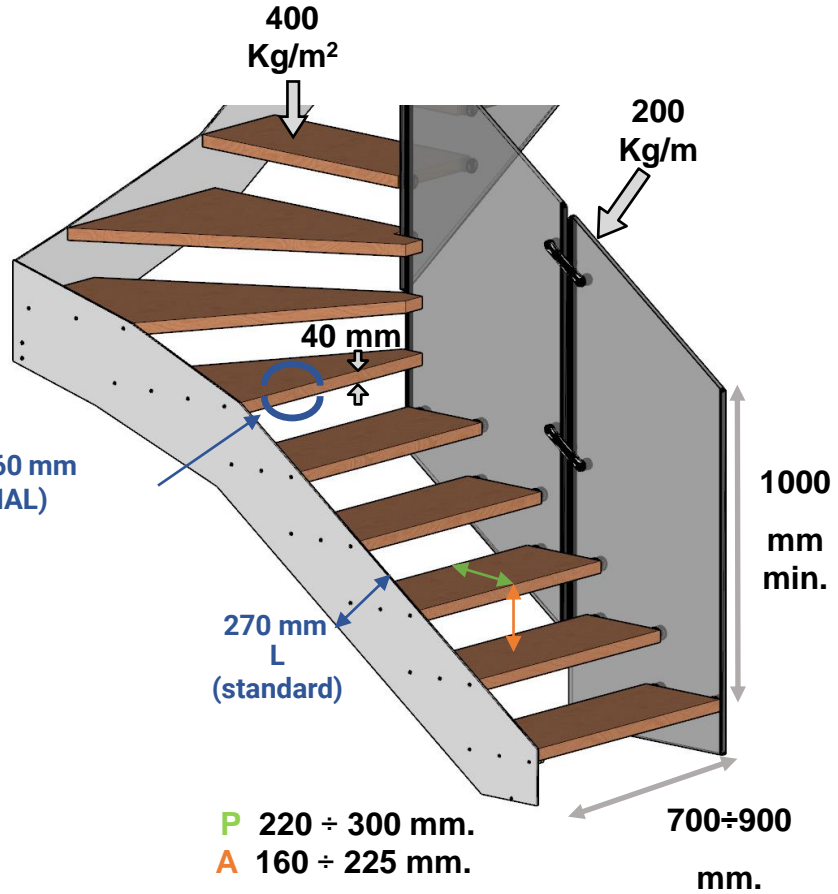

Tipologie di legno disponibili

Type of Wood
 Type de bois
 Holzart
 Tipo de madera



Faggio
 Beech
 Hêtre
 Buche
 Haya



Rovere
 Oak
 Chêne
 Eiche
 Roble

Calcolo passaggio utile

Useful passage - passage utile
 -nützliche Passage - Pasaje útil

$$L - R (26,50 \text{ mm}) = P$$

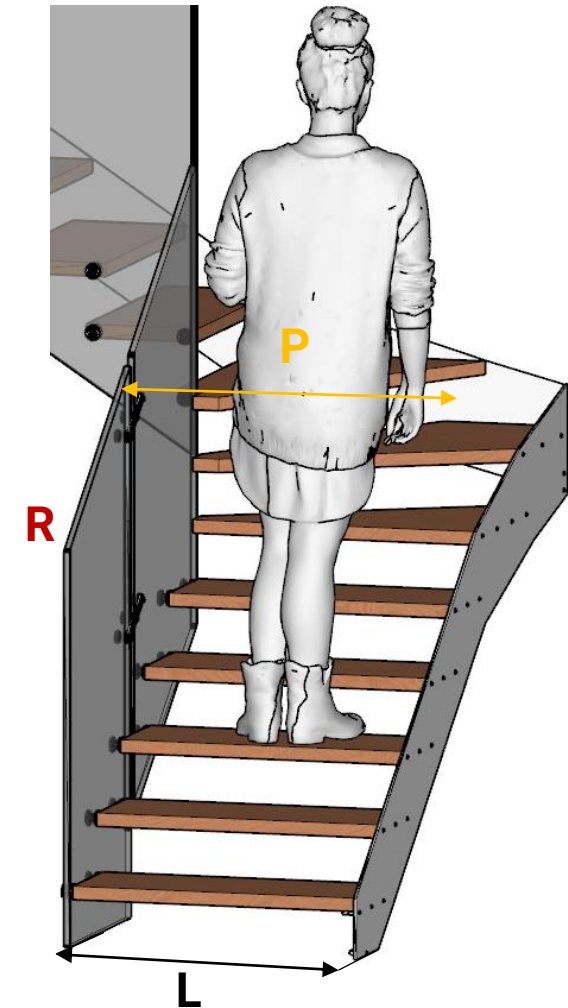

ARRIVO CON ALZATA
ARRIVAL WITH RISER
ARRIVÉ AVEC HAUTEUR
ANKUNFT MIT STEIGUNG
LLEGADA CON CONTRAHUELLA

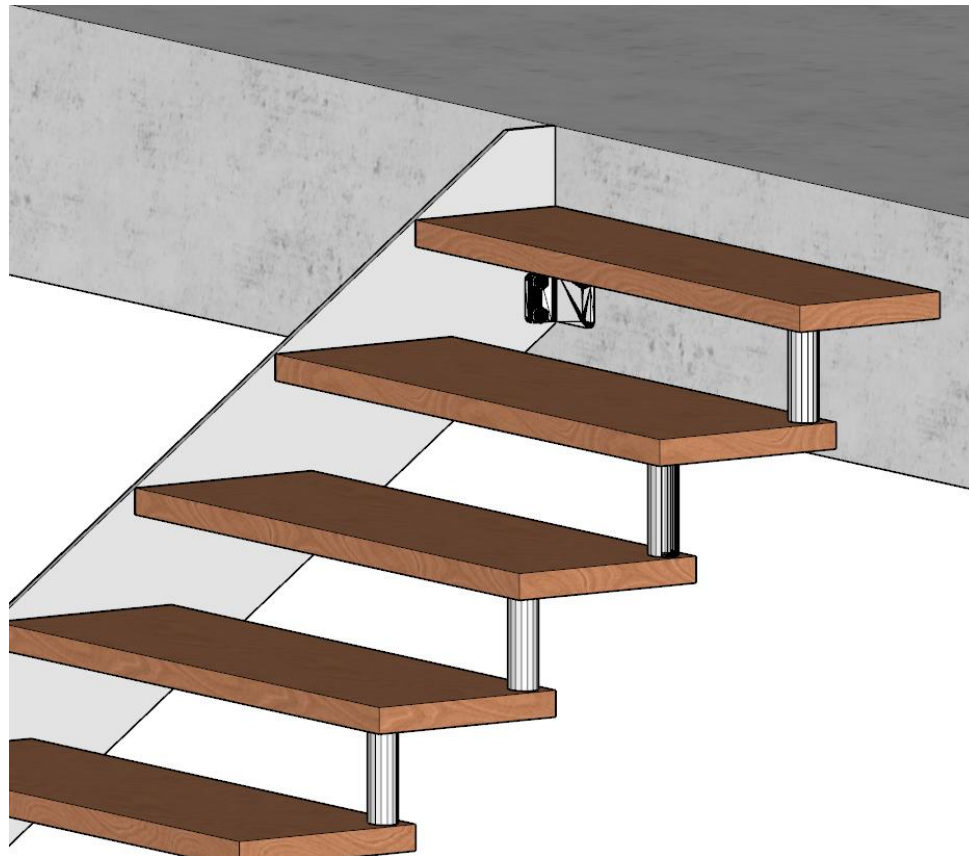

ARRIVO PARI PAVIMENTO
ARRIVAL AT SAME FLOOR LEVEL
ARRIVÉE AU MÊME NIVEAU DU SOL
ERREICHUNG GLEICHEN NIVEAU DES BODENS
LLEGADA MISMO NIVEL QUE EL SUELO

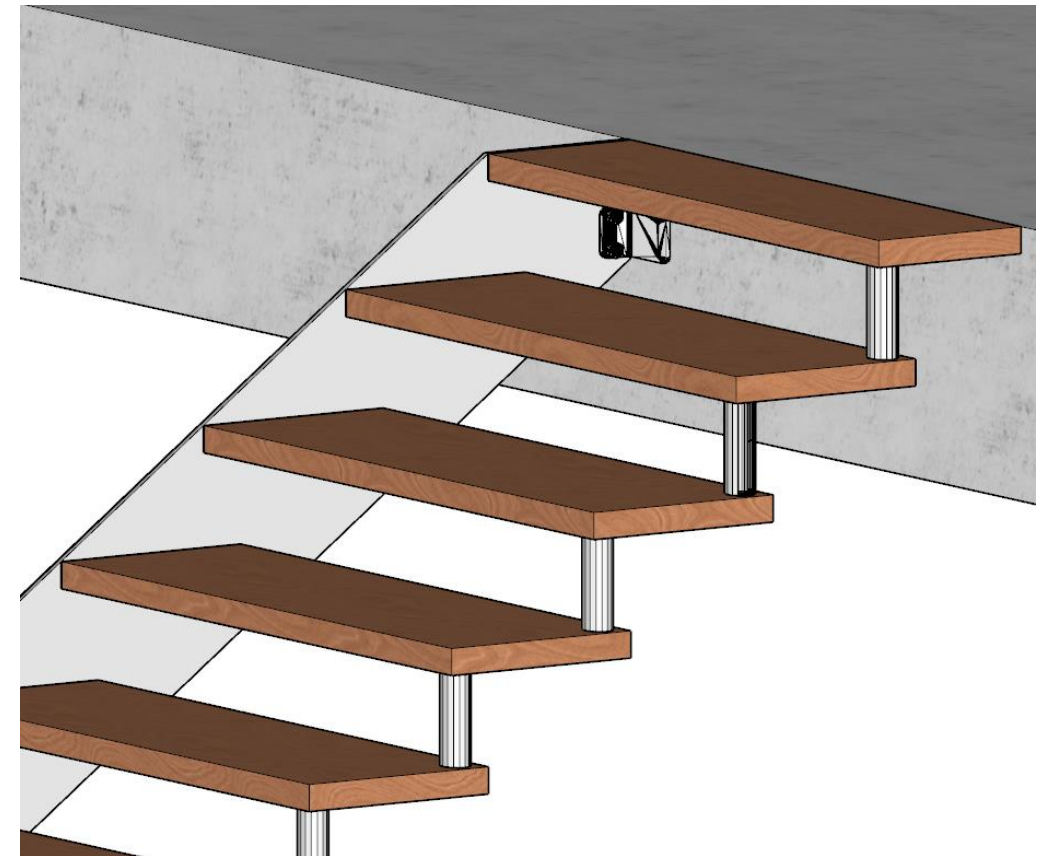

REXAL MONO RX2

PARTENZA DA PAVIMENTO
FLOOR DEPARTURE - DÉPART DU SOL - ABGANG VOM
BODEN - SALIDA DESDE EL SUELO

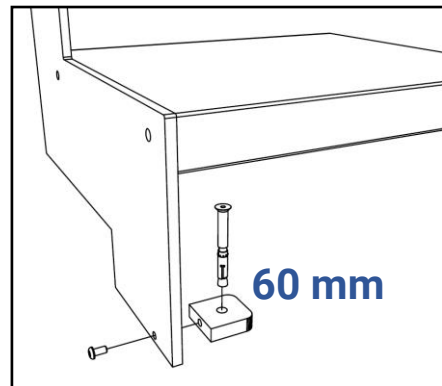
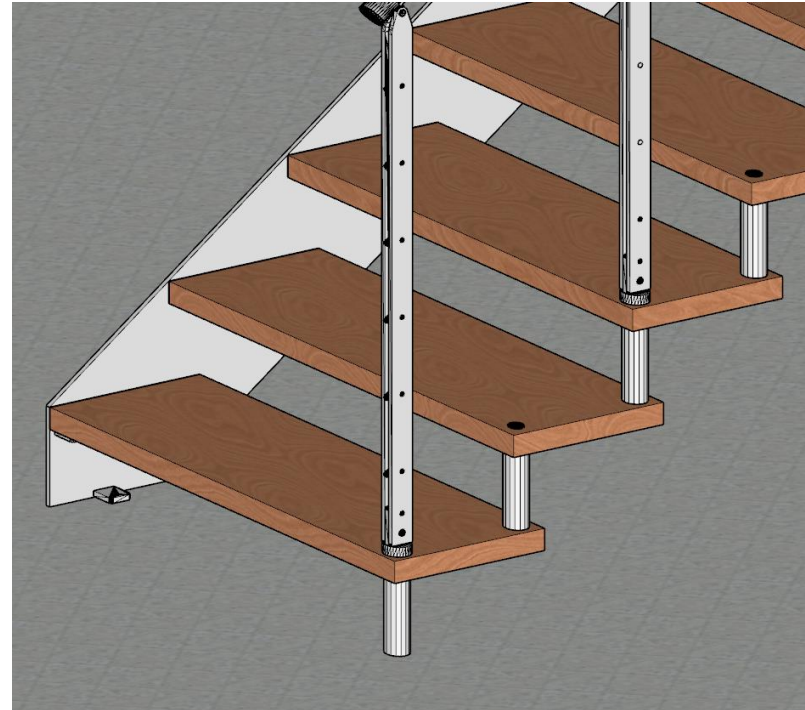

FISSAGGIO A PAVIMENTO
FLOOR FIXING
FIXATION AU SOL
BODENBEFESTIGUNG
FIJACIÓN DEL SUELO

REXAL MONO RX2

BALAUSTRE DISPONIBILI

Available Floor Protection Balustrade – Garde-corps étage disponibles –
Schutzgeländer verfügbar -Barandillas disponibles

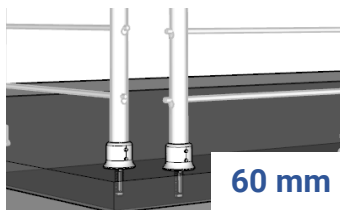
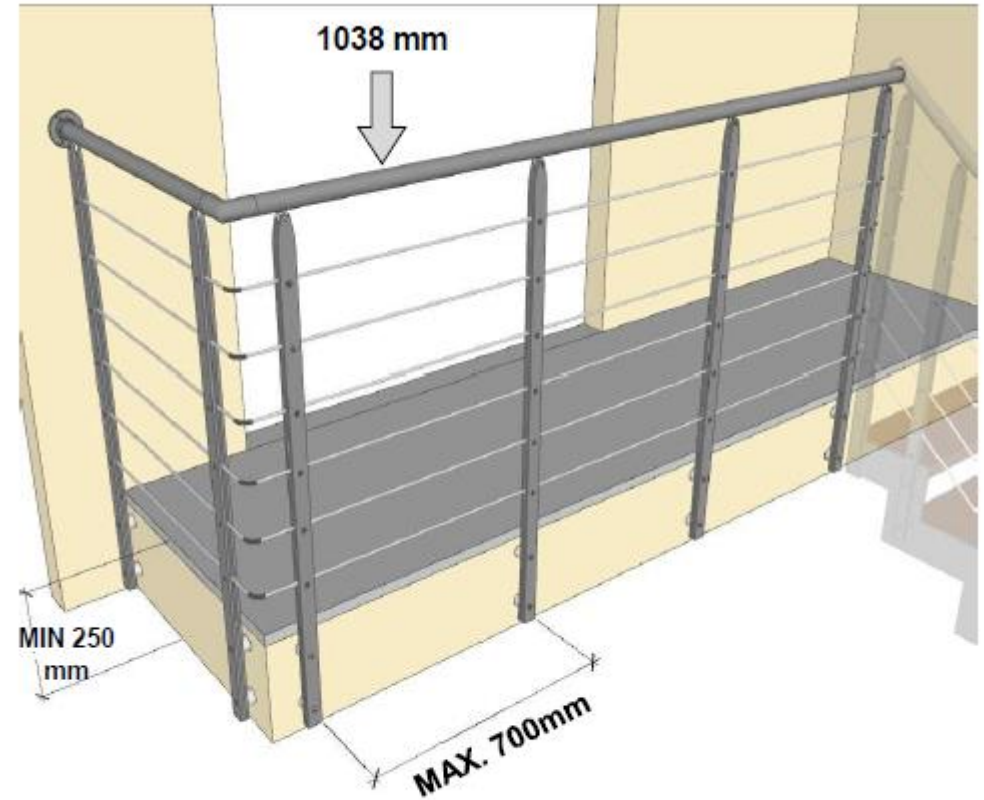
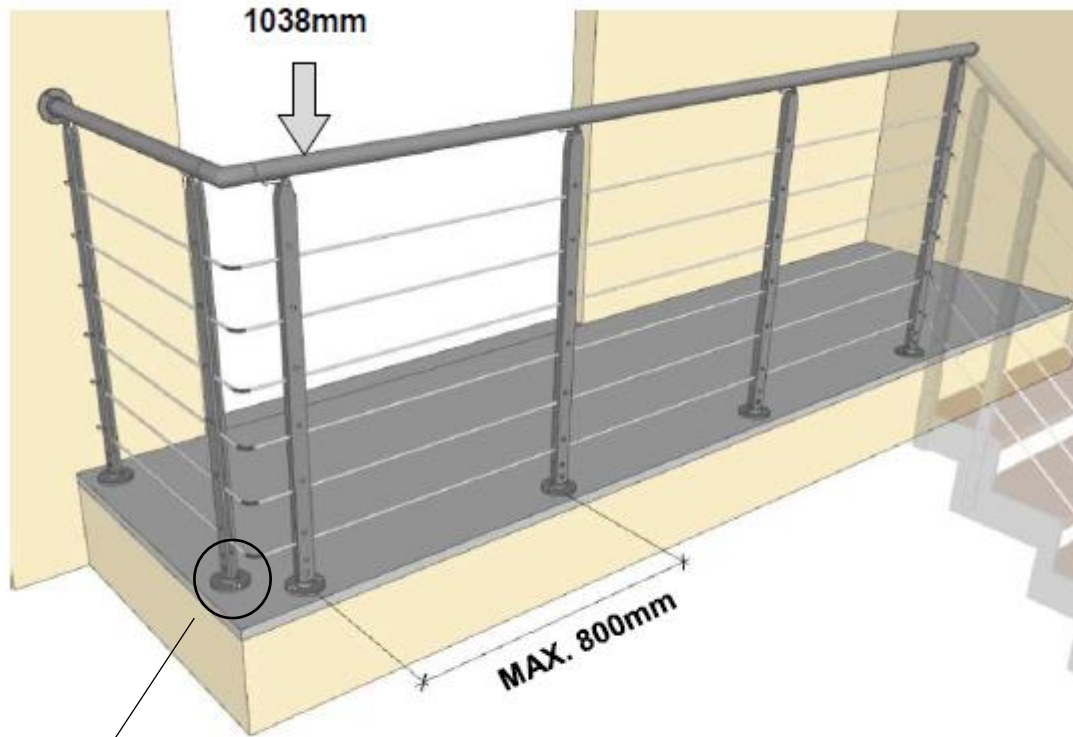

Alzate chiuse

Closed Risers – Contremarches - Setzstufen
Contrahuella cerrada

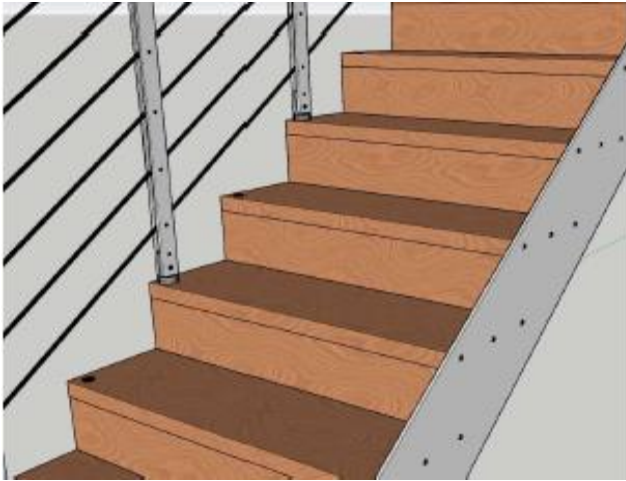

Angolo per pilastro (max 3 gradini)

Corner for Pillar (max 3 steps) – Angle pour Poteau (max 3
marches) - Winkel pro Säule (Max 3 Sufen) - ángulo por pilar
(máximo 3 escalones)

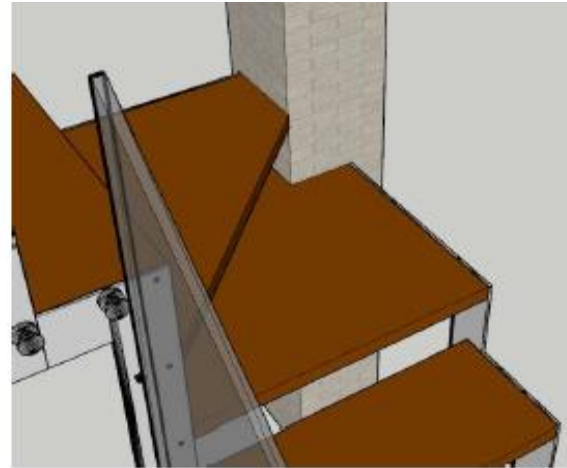

Scala fuori squadra

Out-of-square stair
Escalier hors équerre - Unregelmäßige Treppe
Escalera fuera de escuadra

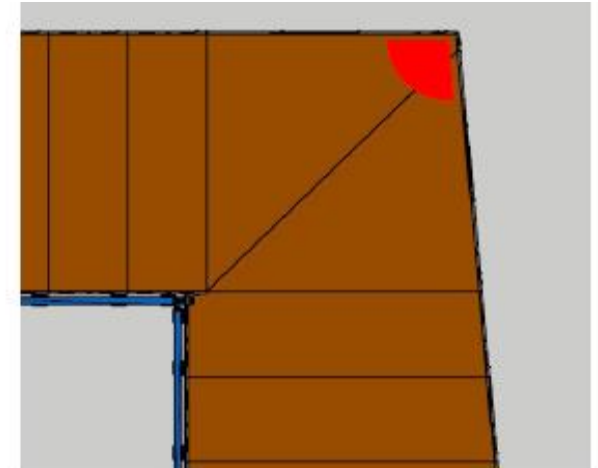

Corrimano a muro

Wall handrail – Main courante murale
Wandhandlauf - Pasamanos de pared



Spot Led

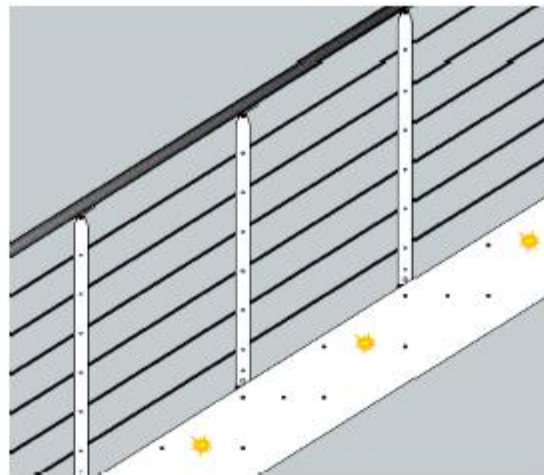

Soglia

Threshold – Seuil – Schwellenwert - Umbral

