



 Scala a chiocciola disponibile con forma tonda;
Gradini in Medium Density Fibreboard bianco;
Palo centrale in metallo;
Ringhiera con colonne verniciate;
Corrimano in PVC grigio.

 Spiral staircase available with round shape;
Steps in white Medium Density Fibreboard;
Metal central pole;
Railing with painted columns;
Grey PVC handrail.

 Escalier en colimaçon disponible avec une forme ronde;
Marches en panneau de fibres à densité moyenne blanc;
Mât central en métal ;
Garde-corps avec colonnes peintes ;
Main courante en PVC gris.

 Wendeltreppe mit runder Form erhältlich;
Stufen aus weißer mitteldichter Faserplatte;
Mittelstange aus Metall;
Geländer mit bemalten Säulen;
Grauer PVC-Handlauf.

 Escalera de caracol disponible con forma redonda;
Peldaños en tablero de fibra de densidad media blanco;
Poste central de metal;
Barandilla con columnas pintadas;
Barandilla de PVC gris.

Dettagli tecnici Technical details - Détails techniques Technische Details - Ficha técnica

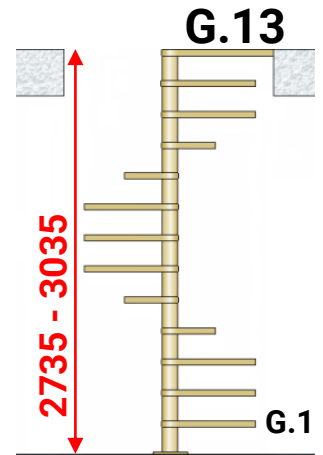
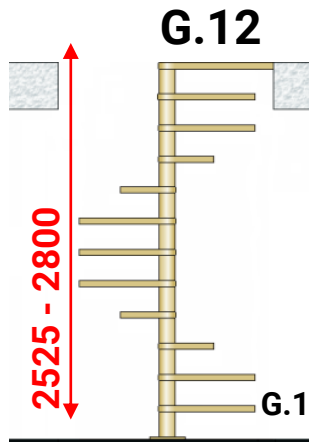
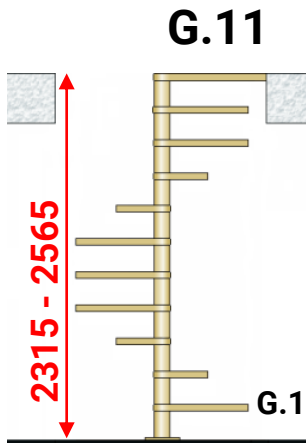

IMBALLO
Dim. 115x97x74 cm
Peso: circa 190/250 kg.

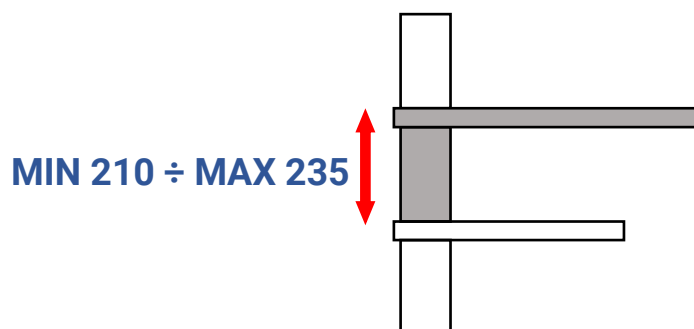
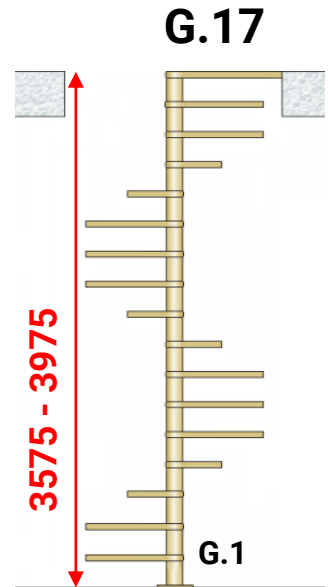
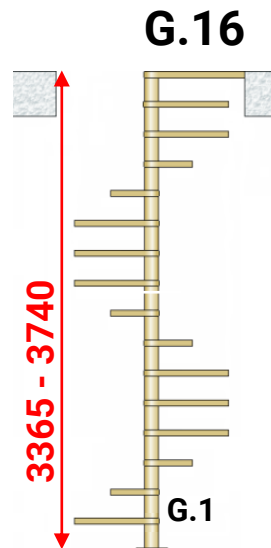
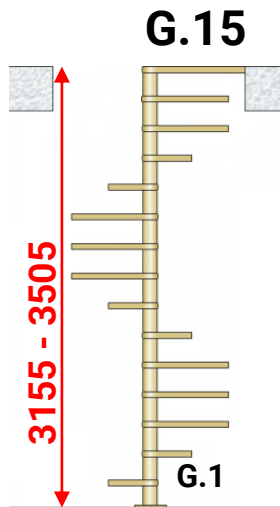
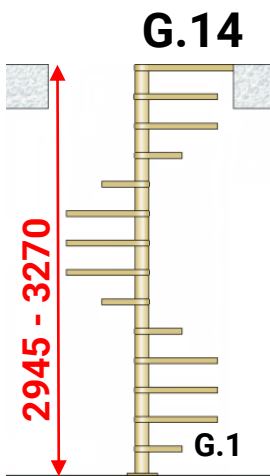

Dettagli tecnici

Technical details - Détails techniques
Technische Details - Ficha técnica

L	C1	C3	P.U.	P.M.
Ø1200	675	649	480	157,9
Ø1400	773	743	580	165,7
Ø1600	873	838	680	189,1

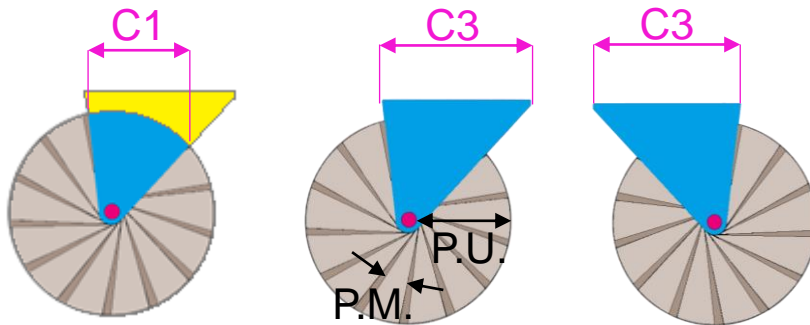

FORO, WELL, TRÉMIE, LOCH, HUECO

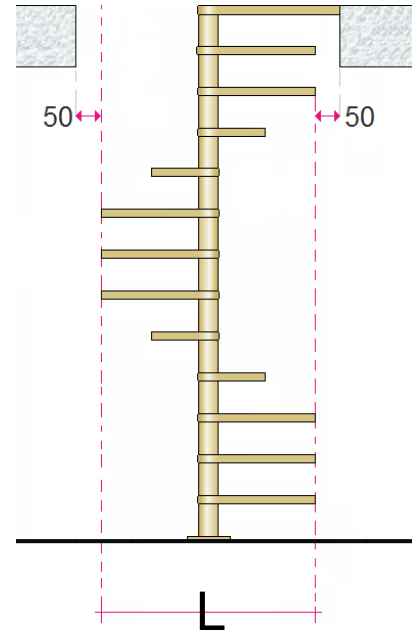

FISSAGGIO ARRIVO SBARCO, FIXING OF THE ARRIVAL LANDING, FIXATION DU PALIER D'ARRIVÉE, BEFESTIGUNG DES ANKUNFTSPODESTS

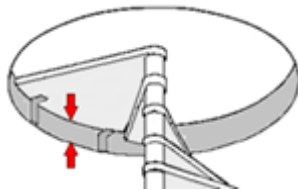

MIN 210

APERTURA GRADINI, TREADS OPENING, OUVERTURE DES MARCHES, ÖFFNUNG DER STUFEN, APERTURA DE LOS ESCALONES

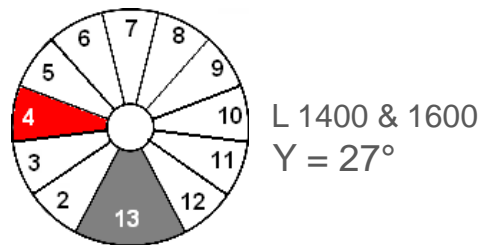
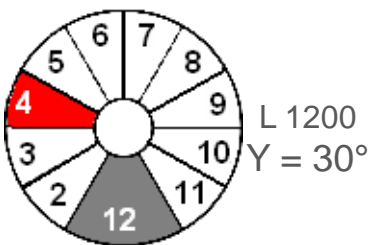

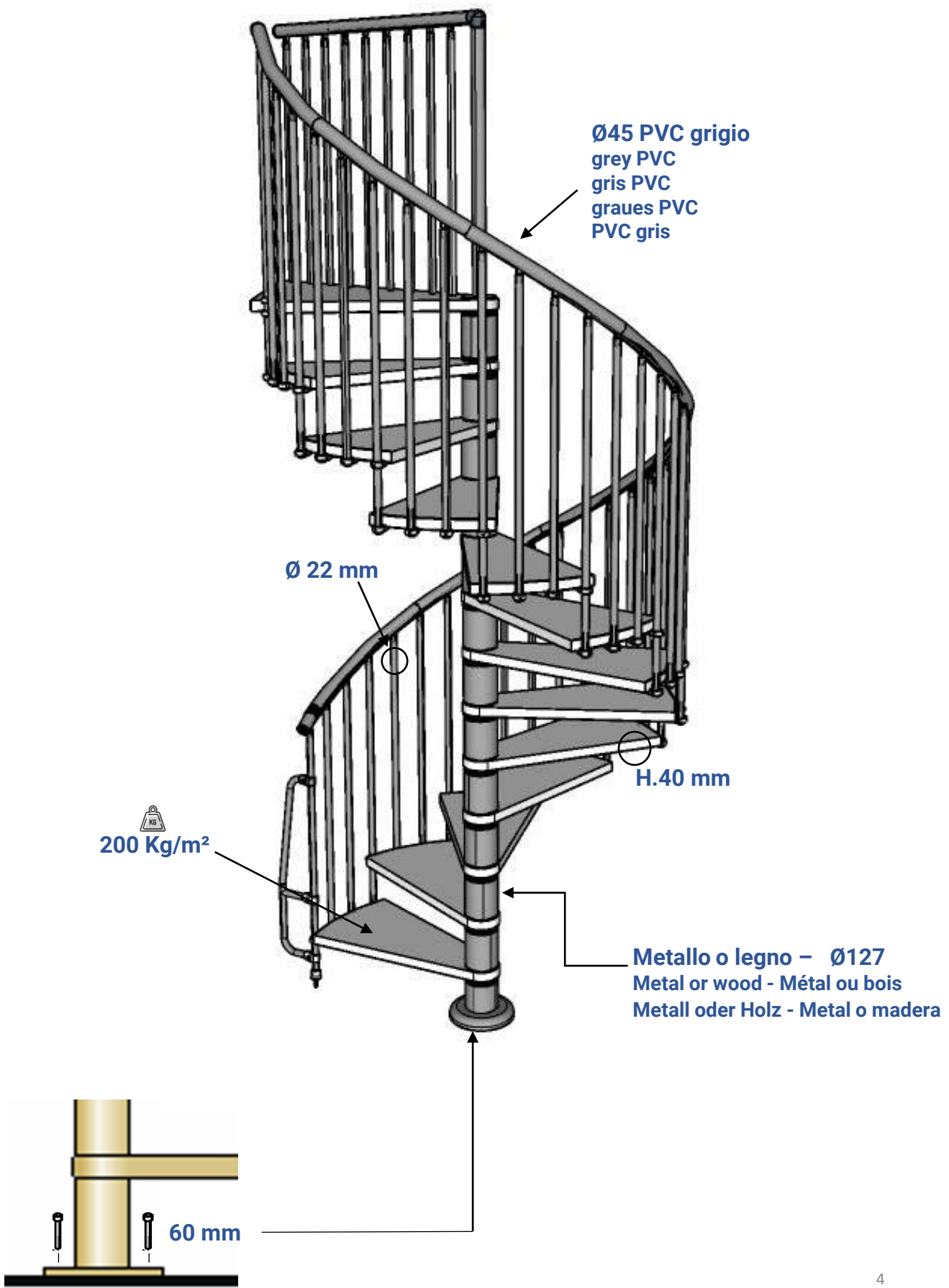

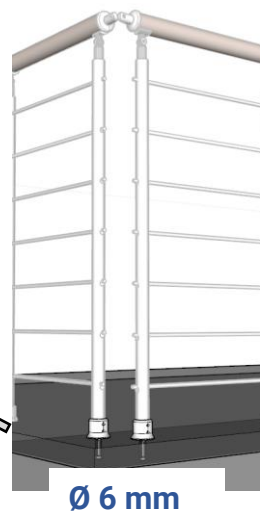
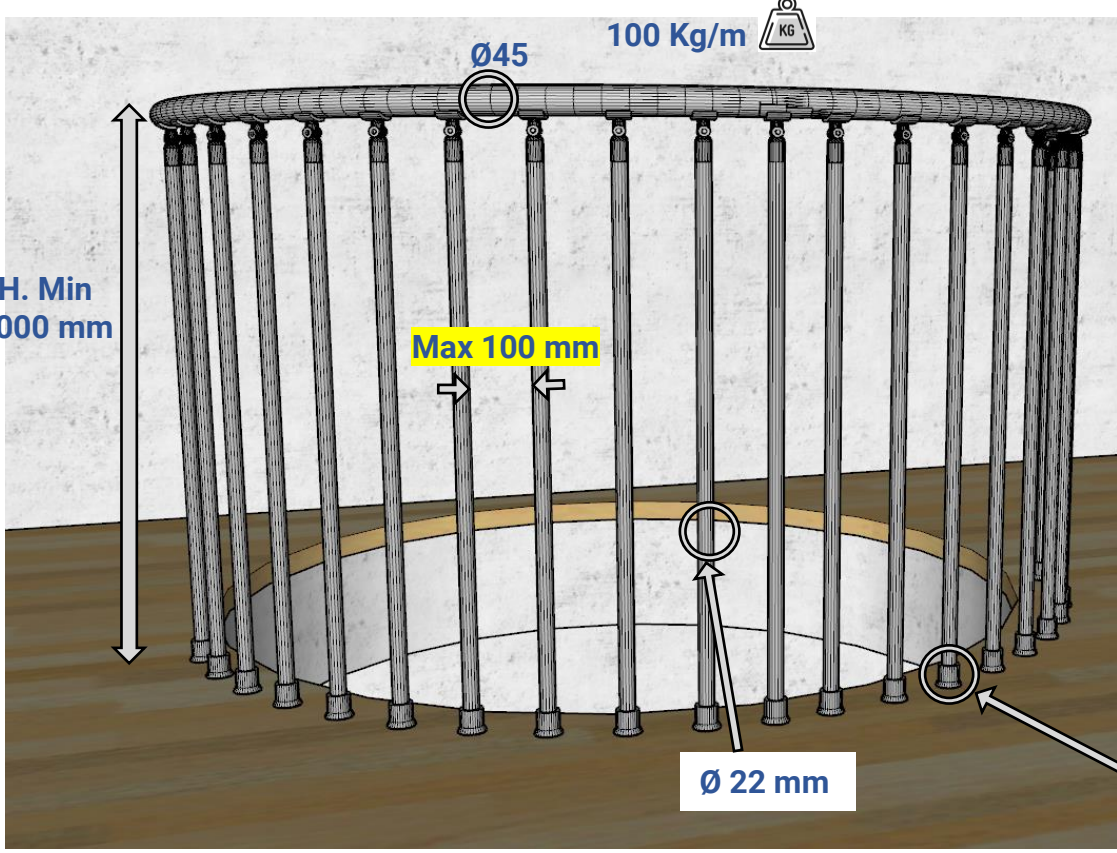
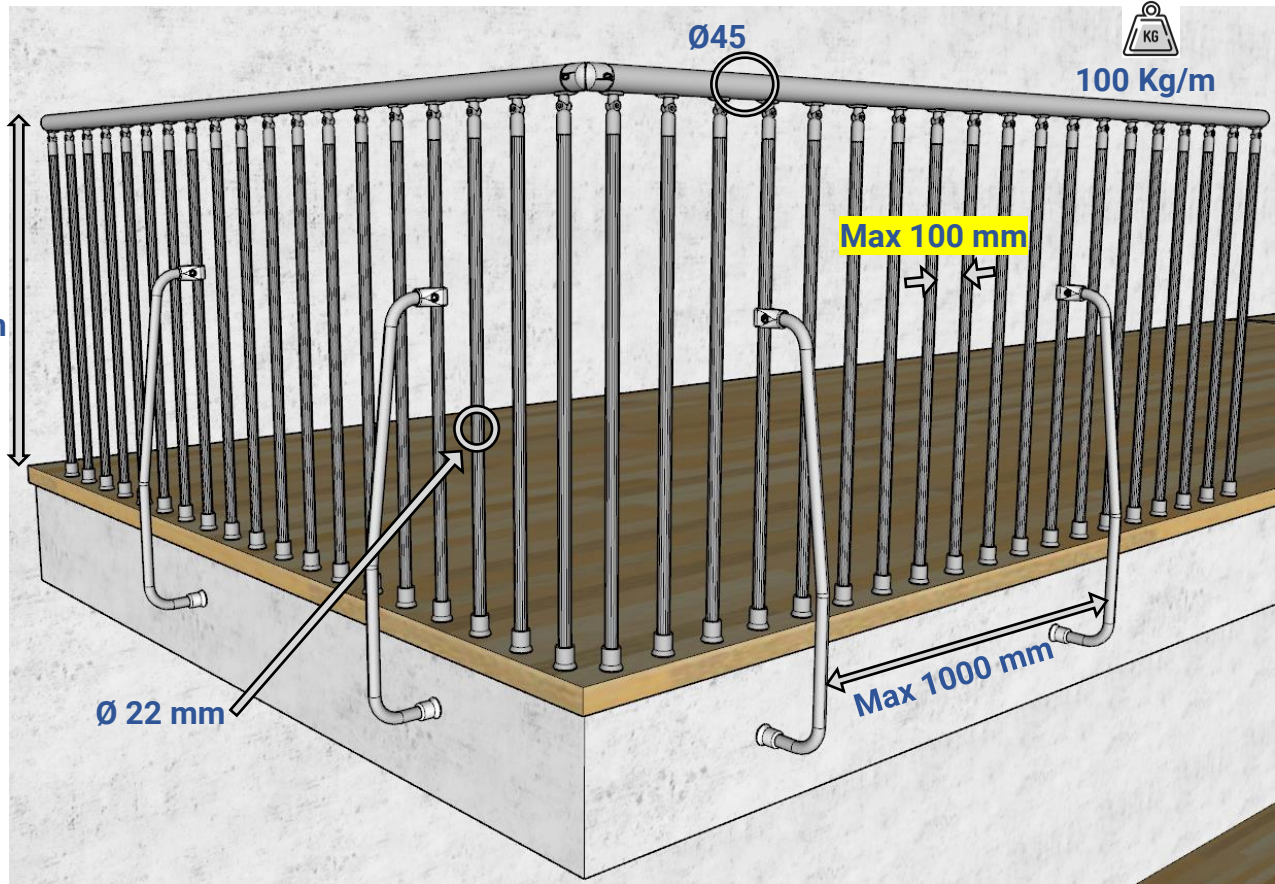

Legno

Wood - Bois
Holz - Madera

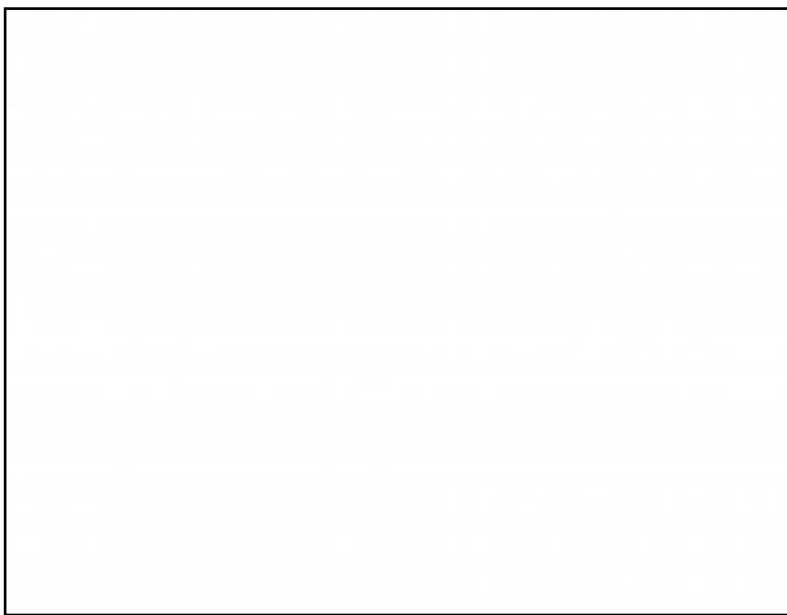

MDF bianco
MDF white
MDF blanc
MDF weiß
MDF blanco

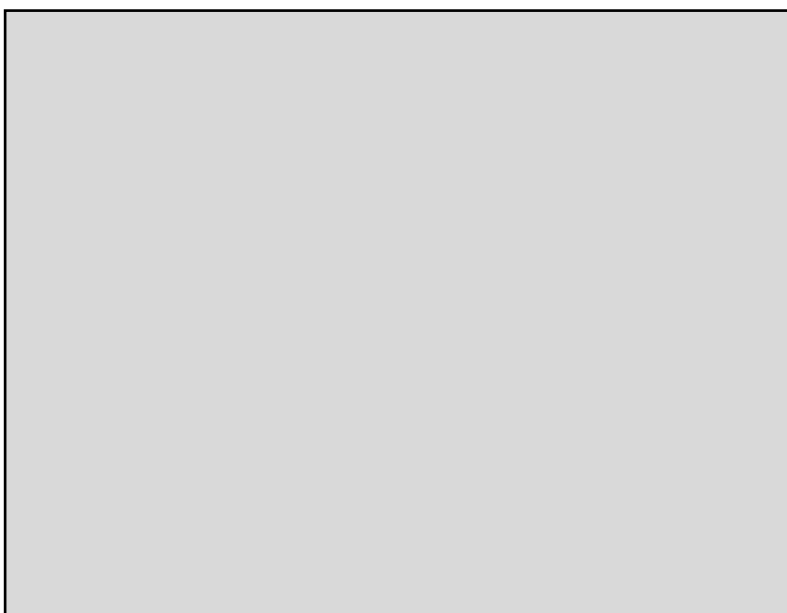

97 RG