



 Scala a chiocciola disponibile con forma tonda;
Gradini in legno di faggio;
Palo centrale in metallo;
Ringhiera con colonne e cavetti in acciaio;
Corrimano in legno massiccio suddiviso in settori.

 Spiral staircase available with round shape;
Beech wood steps;
Central pole in metal;
Railing with stainless steel columns and cables;
Handrail made of solid wood divided into sectors.

 Escalier en colimaçon disponible ronde;
Marches en bois de hêtre ;
Poteau central en métal;
Garde-corps avec colonnes et câbles en acier inoxydable;
Main courante en bois massif divisé en secteurs.

 Spindeltreppe mit runder Form erhältlich;
Stufen aus Buchenholz;
Zentralstange aus Metall;
Geländer mit Edelstahlsäulen und seilen;
Geländer aus Massivholz, unterteilt in Sektoren.

 Escalera de caracol disponible con forma redonda;
Escalones de madera de haya;
Poste central en metal;
Barandilla con columnas y cables de acero inoxidable;
Barandilla fabricado en madera maciza dividida en sectores.

Dettagli tecnici Technical details - Détails techniques Technische Details - Ficha técnica

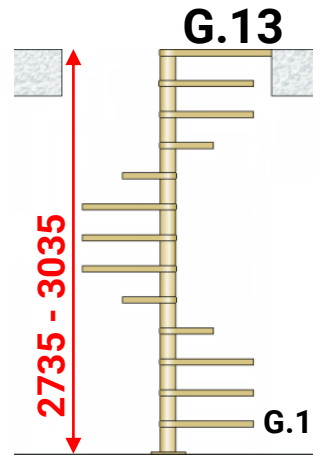
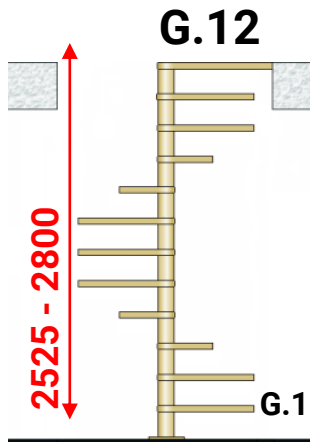
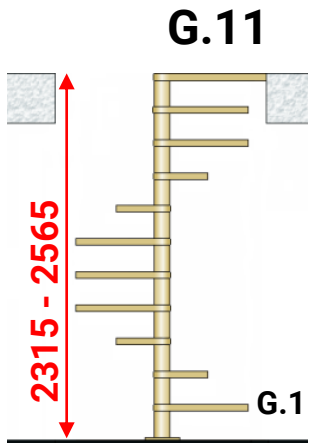

IMBALLO
Dim. 115x97x74 cm
Peso: circa 190/250 kg.

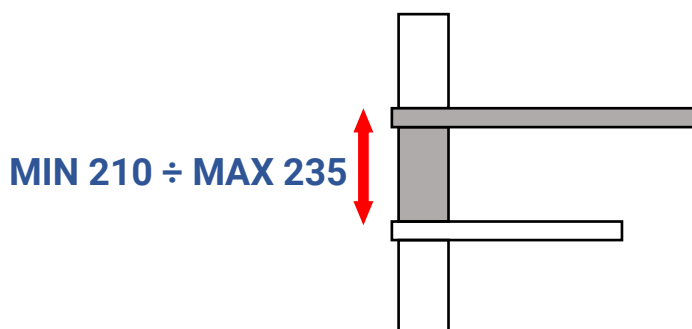
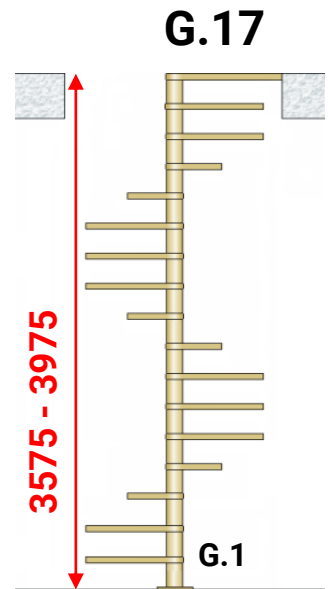
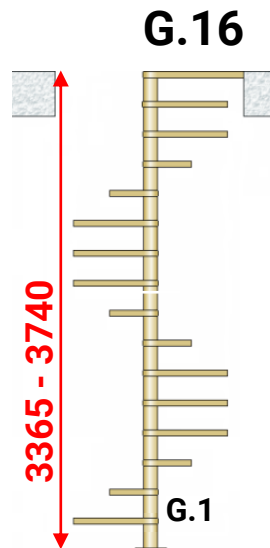
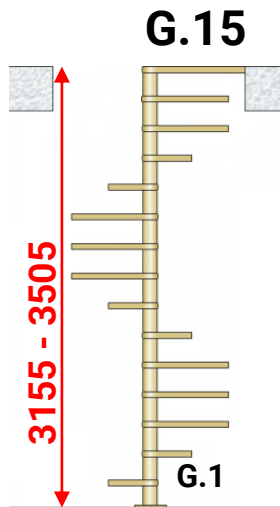
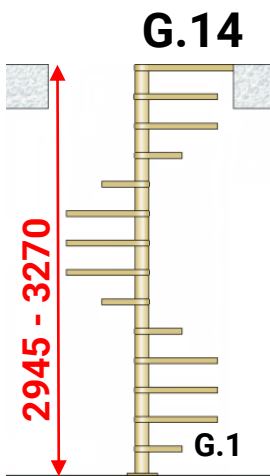

Dettagli tecnici

Technical details - Détails techniques

Technische Details - Ficha técnica

L	C1	C3	P.U.	P.M.
Ø1200	675	649	480	157,9
Ø1400	773	743	580	165,7
Ø1600	873	838	680	189,1

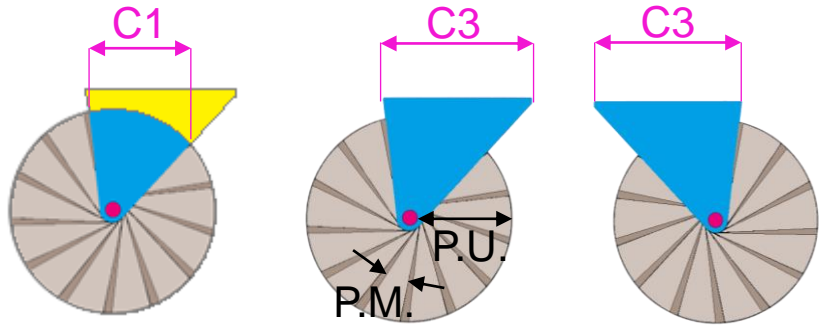

FORO, WELL, TRÊMIE, LOCH, HUECO

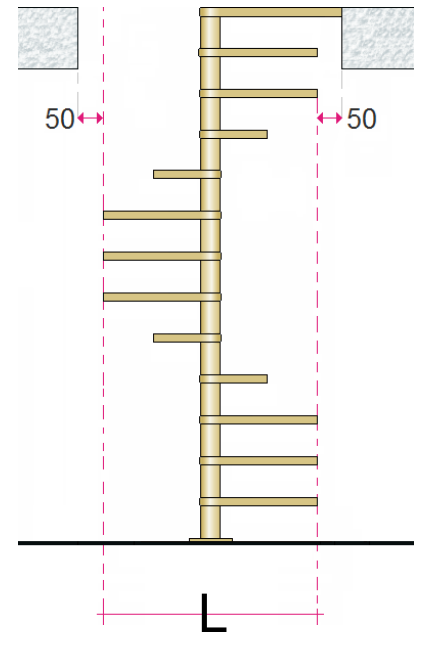

FISSAGGIO ARRIVO SBARCO, FIXING OF THE ARRIVAL LANDING, FIXATION DU PALIER D'ARRIVÉE, BEFESTIGUNG DES ANKUNFTSPODESTS

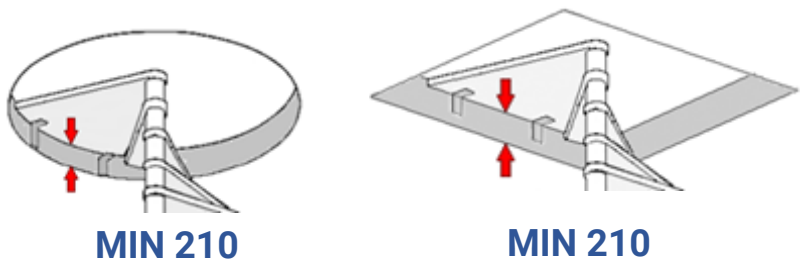

LEGNO, WOOD, BOIS, HOLZ, MADERA



Faggio
Beech
Hêtre
Buche
Haya

APERTURA GRADINI, TREADS OPENING, OUVERTURE DES MARCHES, ÖFFNUNG DER STUFEN, APERTURA DE LOS ESCALONES

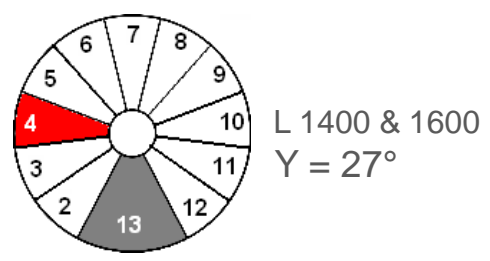
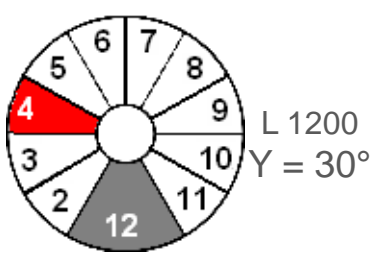

Ø45 Legno
Wood
Bois
Holz
Madera

Ø 22 mm
Ø 4 mm
H.40 mm

200 Kg/m²

Metallo o legno - Ø127
Metal or wood - Métal ou bois
Metall oder Holz - Metal o madera

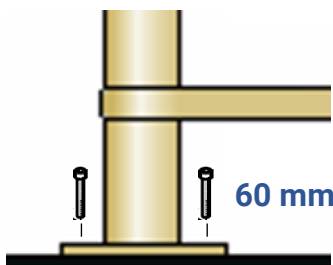

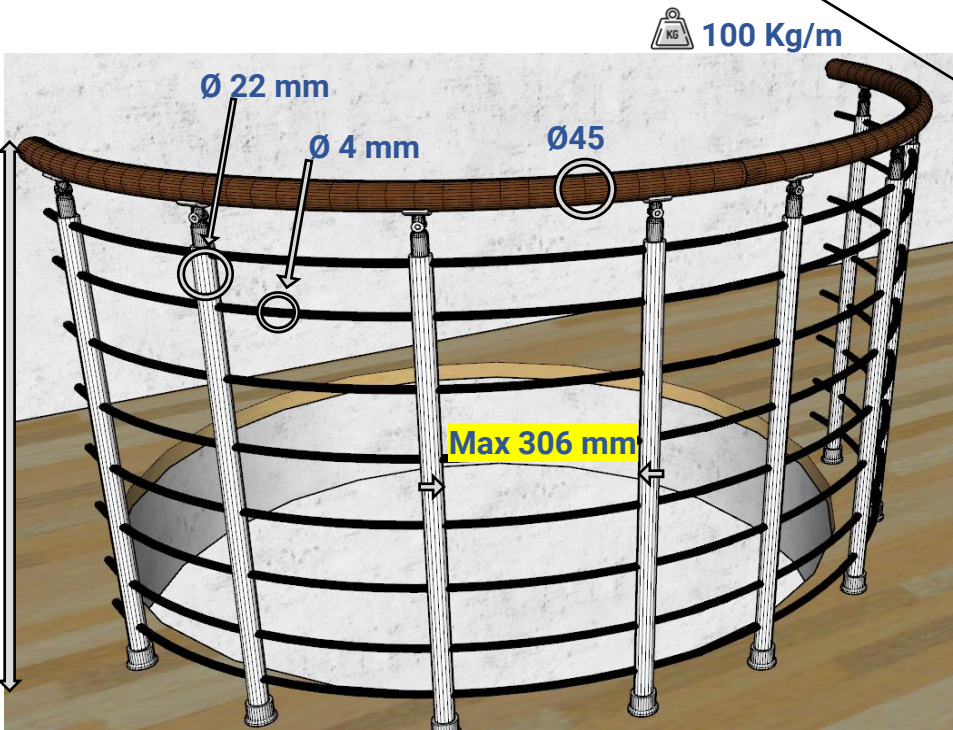
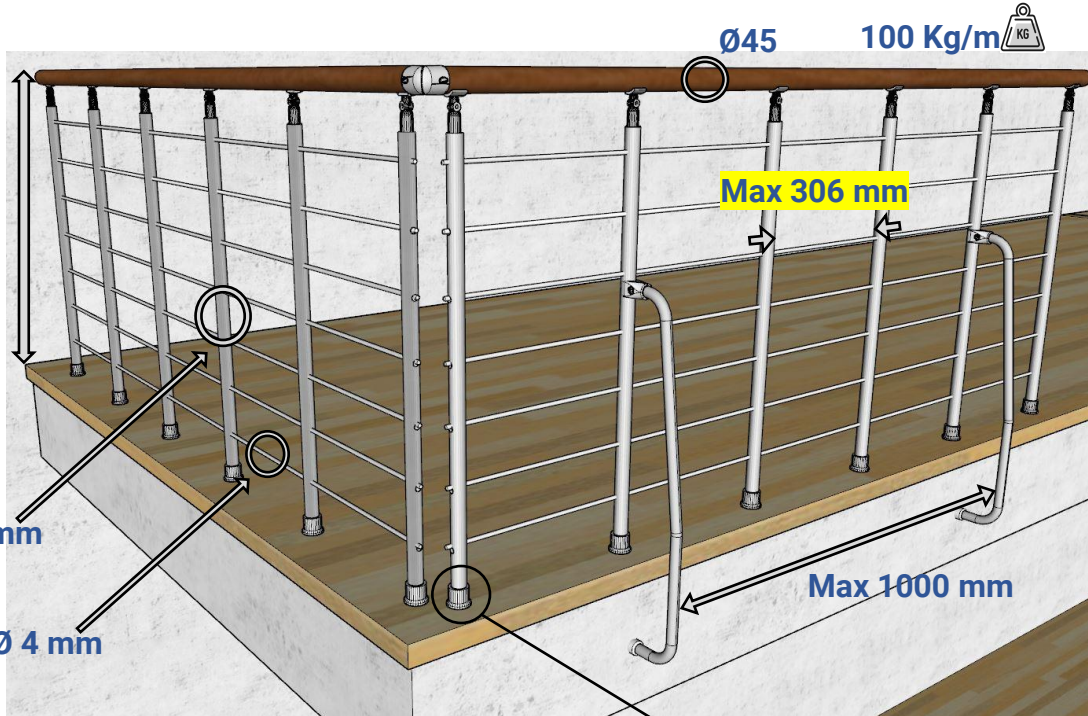

Legno
Wood - Bois
Holz - Madera



253 Naturale
Natural
Naturbuchenholz
Couleur naturelle
Natural



252 Noce medio
Light chestnut
Noyer moyen
Nussbaumholz
Nogal medio

Metallo
Metal
Métal
Metall
Metal

Componenti termoplastici
Thermoplastic components
Composants thermoplastiques
Thermoplastische Bauteile
Componentes termoplásticos

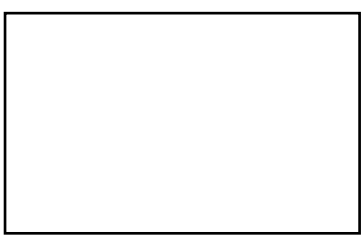

90 RG

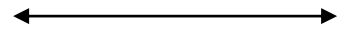

97 RG



95 RG

