 Scala a chiocciola da esterno disponibile con forma tonda, composta da gradini in metallo zincati a caldo e sbarco universale che si adatta ad ogni tipologia di foro.

Palo centrale in metallo;

Ringhiera composta da 3 colonne per gradino;

Corrimano in PVC grigio.

 Outdoor spiral staircase available with a round shape, consisting of hot-dip galvanized metal steps and universal landing that adapts to any type of hole.

Central metal pole;

Railing consisting of 3 columns per step;

Grey PVC handrail.

 Escalier extérieur en colimaçon de forme ronde, composé de marches en métal galvanisé à chaud et d'un palier universel qui s'adapte à tout type de trou.

Poteau métallique central ;

Garde-corps composé de 3 colonnes par marche ;

Main courante en PVC gris.

 Runde Wendeltreppe für den Außenbereich, bestehend aus feuerverzinkten Metallstufen und einem universellen Podest, das sich an jede Art von Loch anpasst.

Zentraler Metallpfosten;

Geländer bestehend aus 3 Säulen pro Stufe;

Handlauf aus grauem PVC.

 Escalera de caracol exterior disponible con forma redonda, compuesta por peldaños metálicos galvanizados en caliente y rellano universal que se adapta a cualquier tipo de hueco.

Poste metálico central;

Barandilla compuesta por 3 columnas por escalón;

Barandilla de PVC gris.

Dettagli tecnici Technical details - Détails techniques Technische Details - Ficha técnica

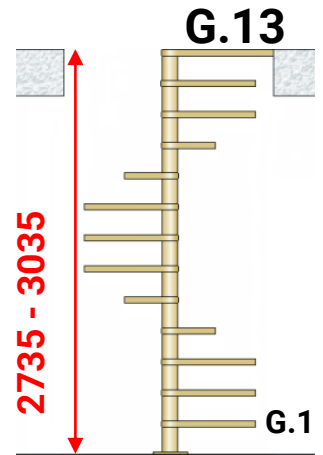
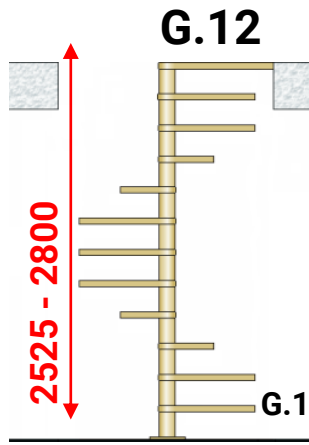
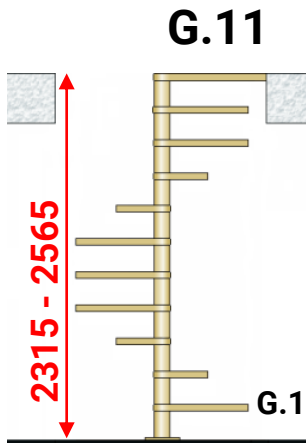

IMBALLO
Dim. 115x97x74 cm (G.12)
Peso: circa 190/250 kg.



IMBALLO
Dim. 110x97x100 cm
(G.12 Diam. 160 cm)
Peso: circa 190/250 kg.

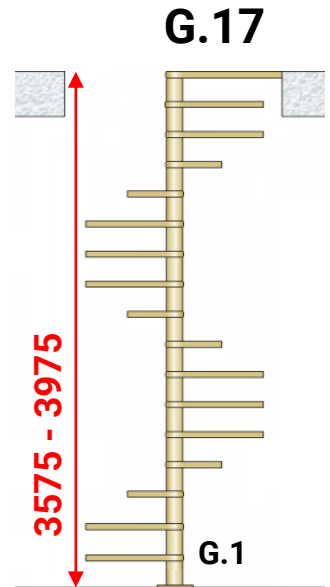
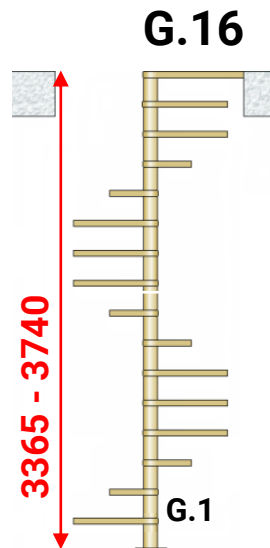
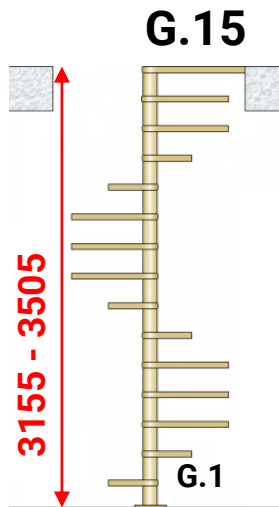
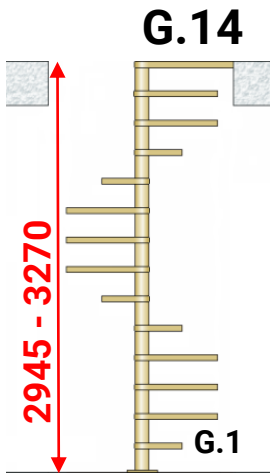

MIN 210 ÷ MAX 235

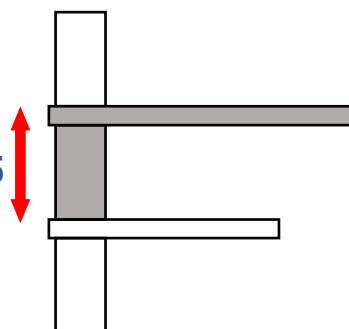

Dettagli tecnici

Technical details - Détails techniques
Technische Details - Ficha técnica

L	C2	P.U.	P.M.
Ø1200	711	499	155,6
Ø1400	813	599	163,6
Ø1600	915	699	187,0

FORO, WELL, TRÊMIE, LOCH, HUECO

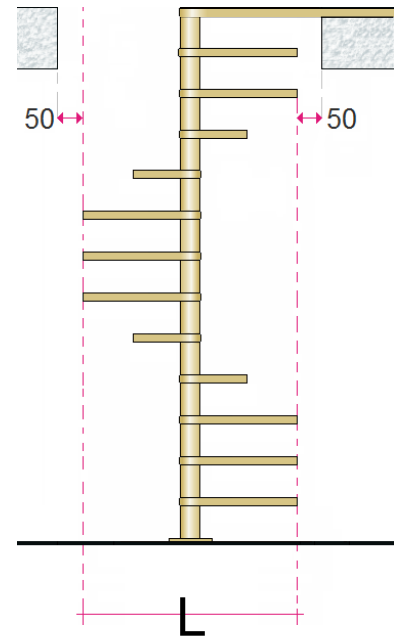
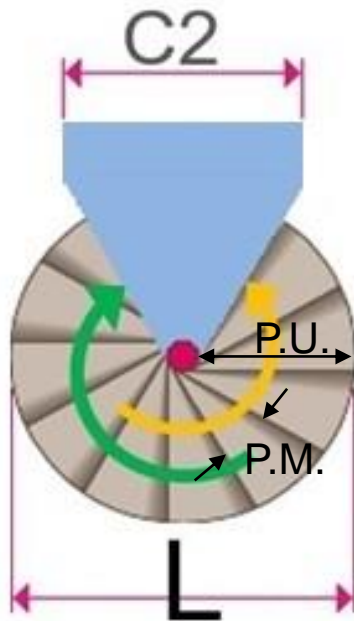

FISSAGGIO ARRIVO SBARCO, FIXING OF THE ARRIVAL LANDING,
FIXATION DU PALIER D'ARRIVÉE, BEFESTIGUNG DES ANKUNFTSPODESTS

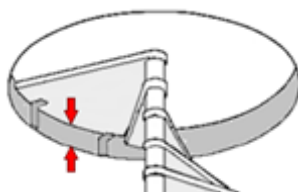

MIN 210

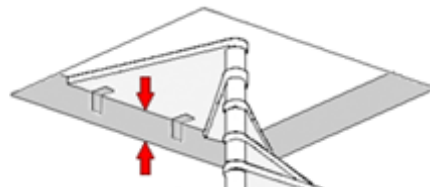

MIN 210

APERTURA GRADINI, TREADS OPENING, OUVERTURE DES MARCHES,
ÖFFNUNG DER STUFEN, APERTURA DE LOS ESCALONES

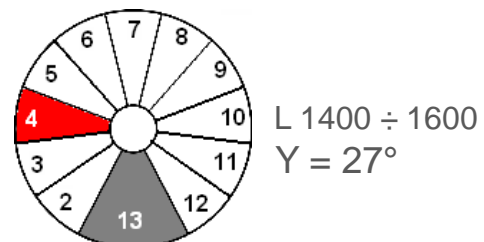
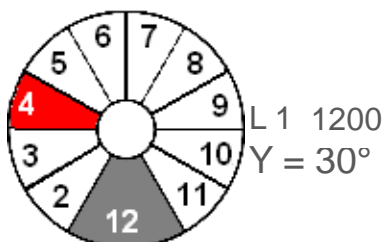

Ø45 PVC grigio
grey PVC
gris PVC
graus PVC
PVC gris

Ø 22 mm

 200 Kg/m²

Zincatura a caldo
hot-dip galvanized
galvanisé à chaud
Feuerverzinkt
galvanizado en caliente

Striscia antiscivolo
Anti-slip strip
Bande antidérapante
Anti-Rutsch-Streifen
Tira antideslizante

60 mm

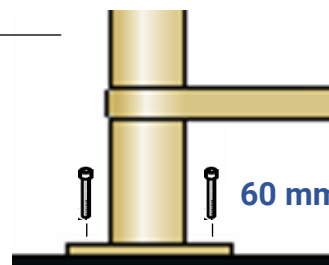
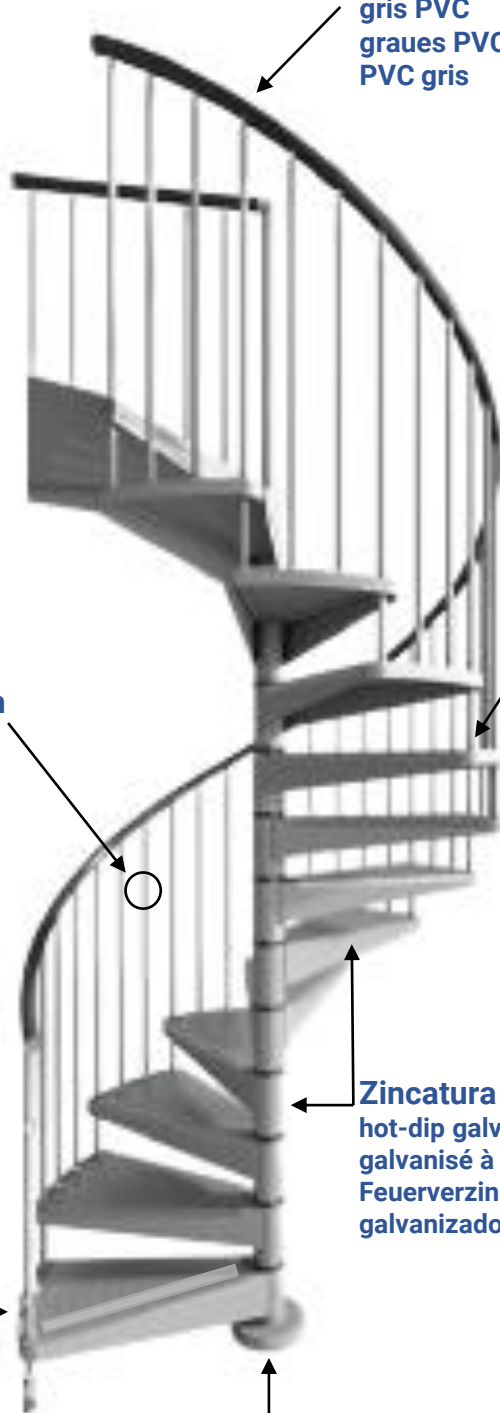

Balaustra

Balustrade – Balustrade
Balustrade - Balaustrada

