

## Forme · Formes · Shapes · Formen · Formas

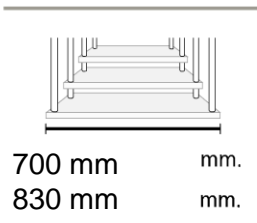

	G10	G11	G12	G13	G14	G15	G16	G17
h	h	h	h	h	h	h	h	h
	1905	2075	2245	2415	2585	2755	2925	3095
	2555	2790	3025	3260	3495	3730	3965	4200

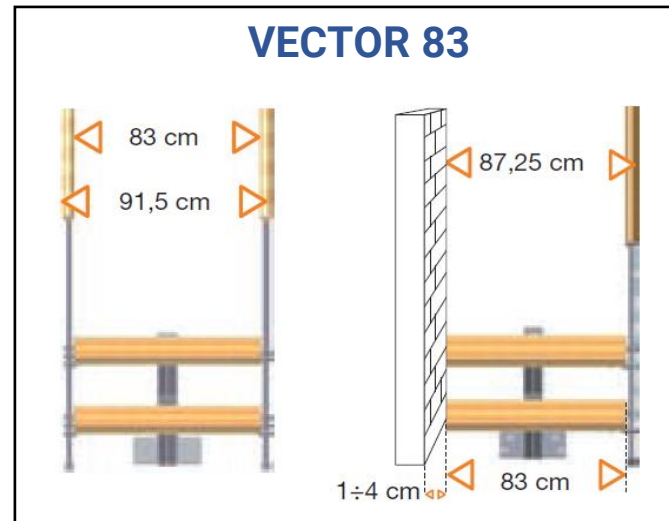
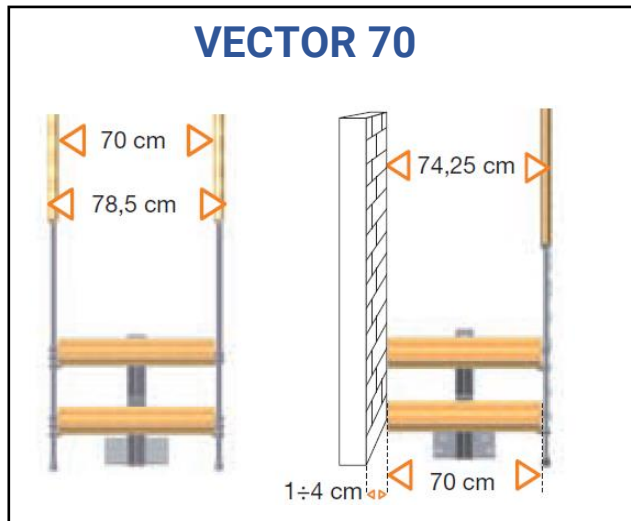
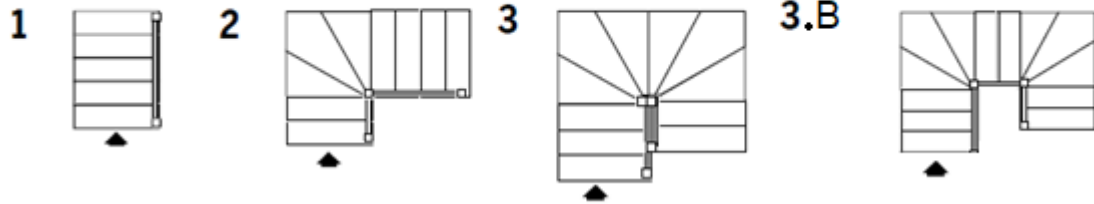

Ø45 Legno  
Wood  
Bois  
Holz  
Madera

# VECTOR

## Caratteristiche tecniche

Technical specifications  
Spécifications techniques  
Technische Daten  
Características técnicas

400 Kg/m<sup>2</sup>

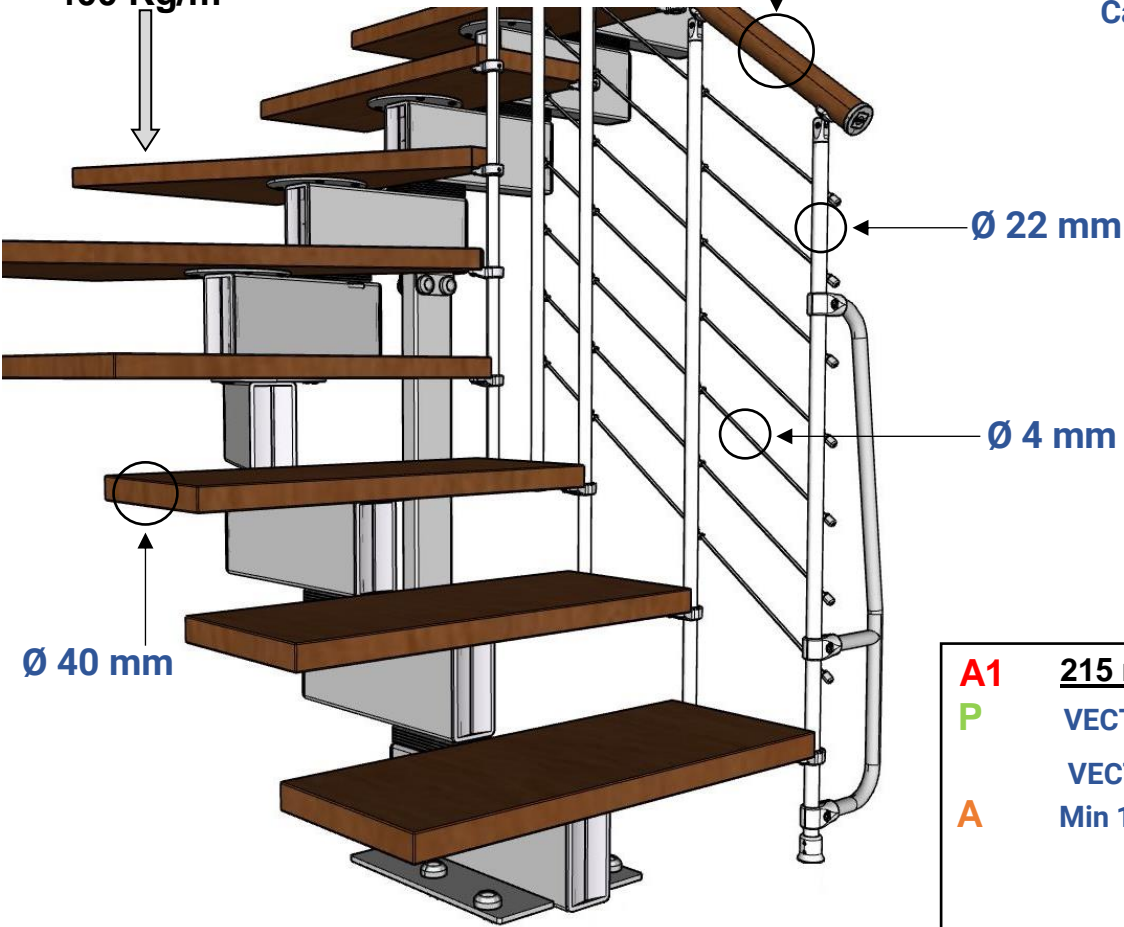

**A1** 215 mm Fissa (Sets; Fixe; Fest; Fijo)

**P** VECTOR 700: min 200 – max 230 mm

VECTOR 830: min 220 – max 250 mm

**A** Min 170 - Max 235 mm

+0.00 **A1**

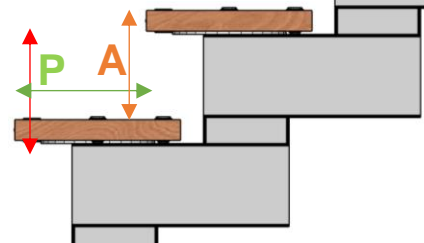

## Calcolo passaggio utile

Useful passage - passage utile  
nützliche Passage - Pasaje útil

**P.U. = 700 o 830 mm**

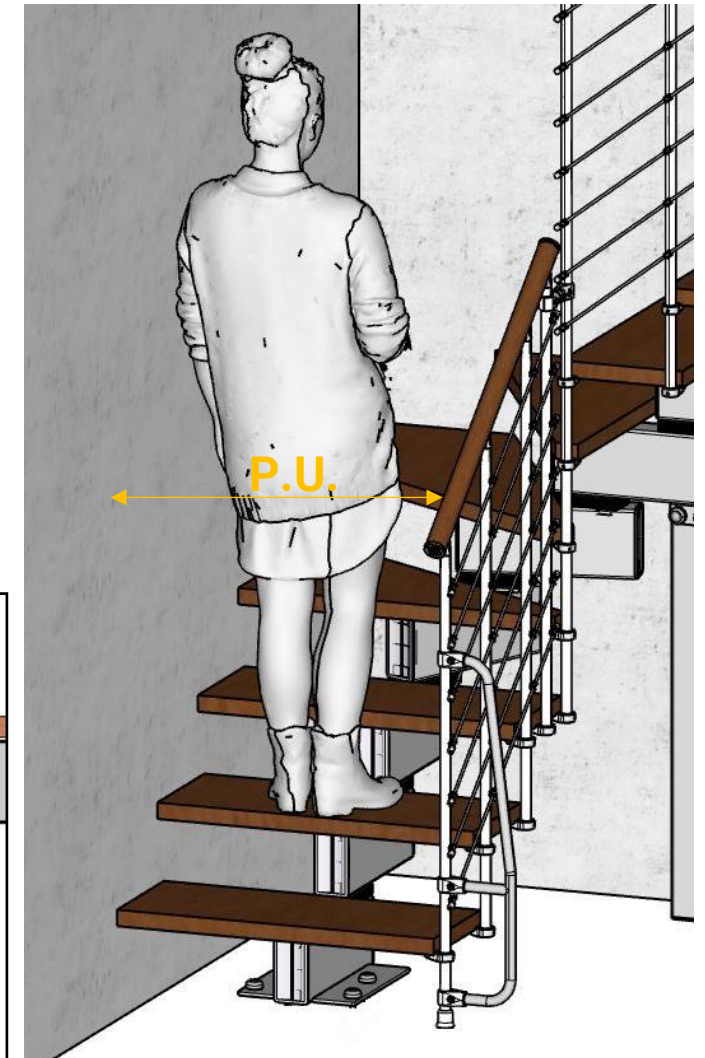



**ARRIVO CON ALZATA**  
ARRIVAL WITH RISER  
ARRIVÉ AVEC HAUTEUR  
ANKUNFT MIT STEIGUNG  
LLEGADA CON CONTRAHUELLA

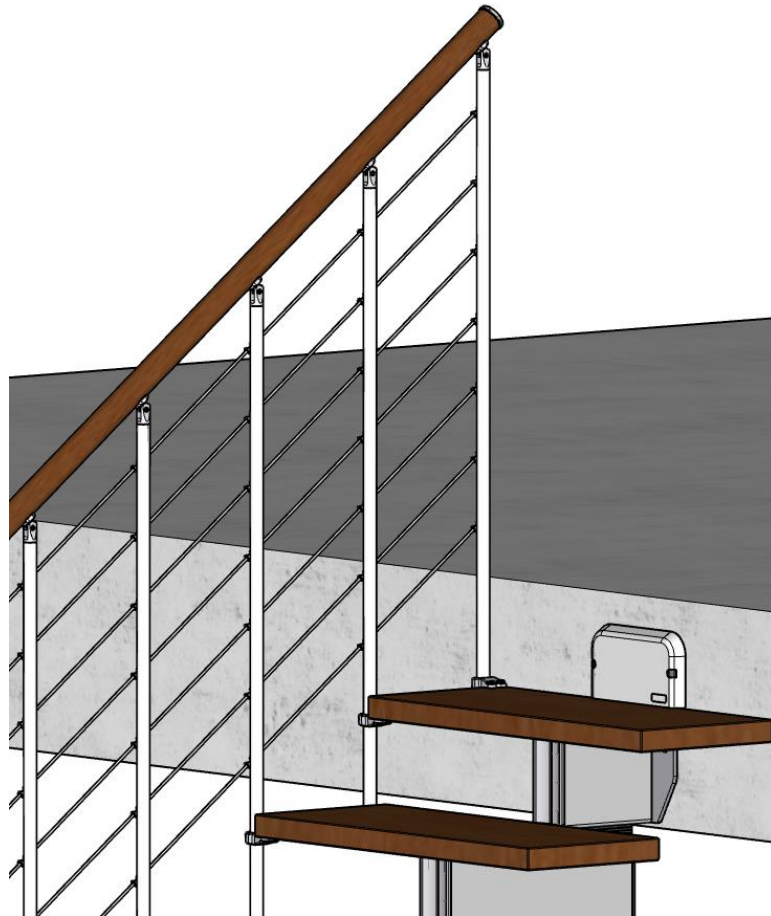

**PARTENZA DA PAVIMENTO**  
FLOOR DEPARTURE  
DÉPART DU SOL  
ABGANG VOM BODEN  
SALIDA DESDE EL SUELO

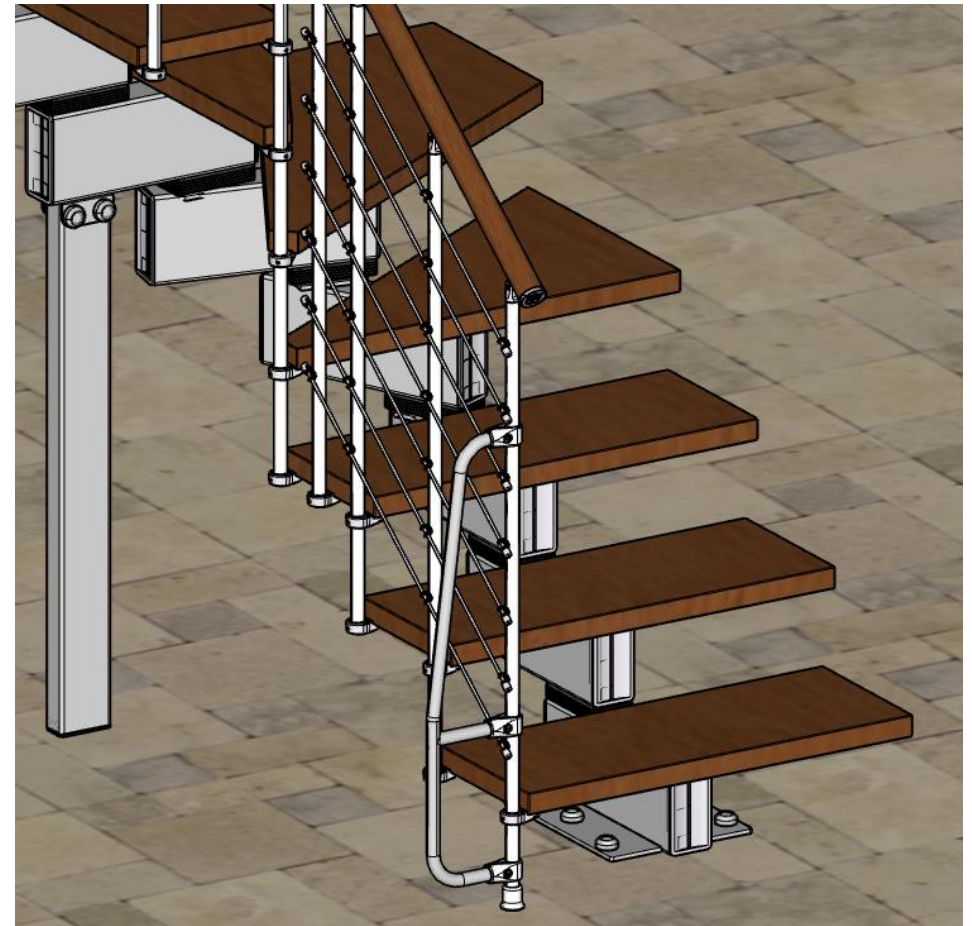

## PILASTRO DI SOSTEGNO

SUPPORT PILLAR  
PILIER DE SOUTIEN  
STÜTZPFEILER  
PILAR DE SOPORTE

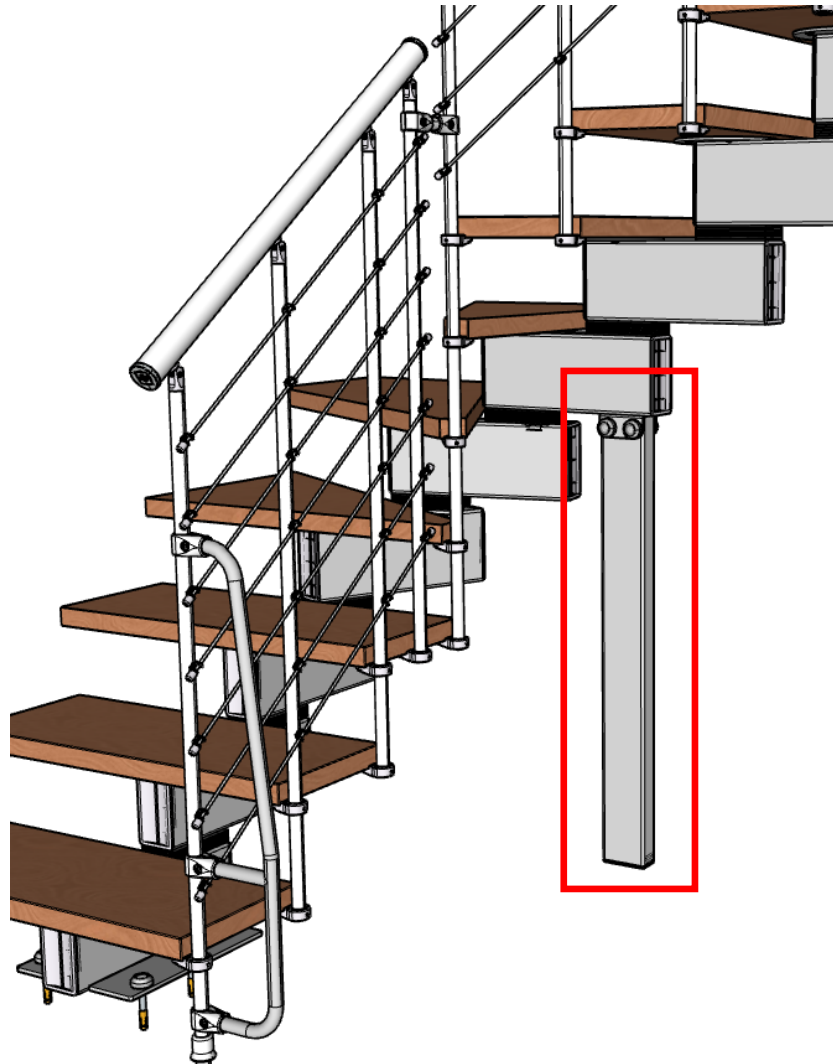

## MENSOLA DA MURARE

SHELF TO BE WALLED UP  
ÉTAGÈRE À MURER  
REGAL ZUM ZUWANDEN  
ESTANTERÍA PARA TAPIAR

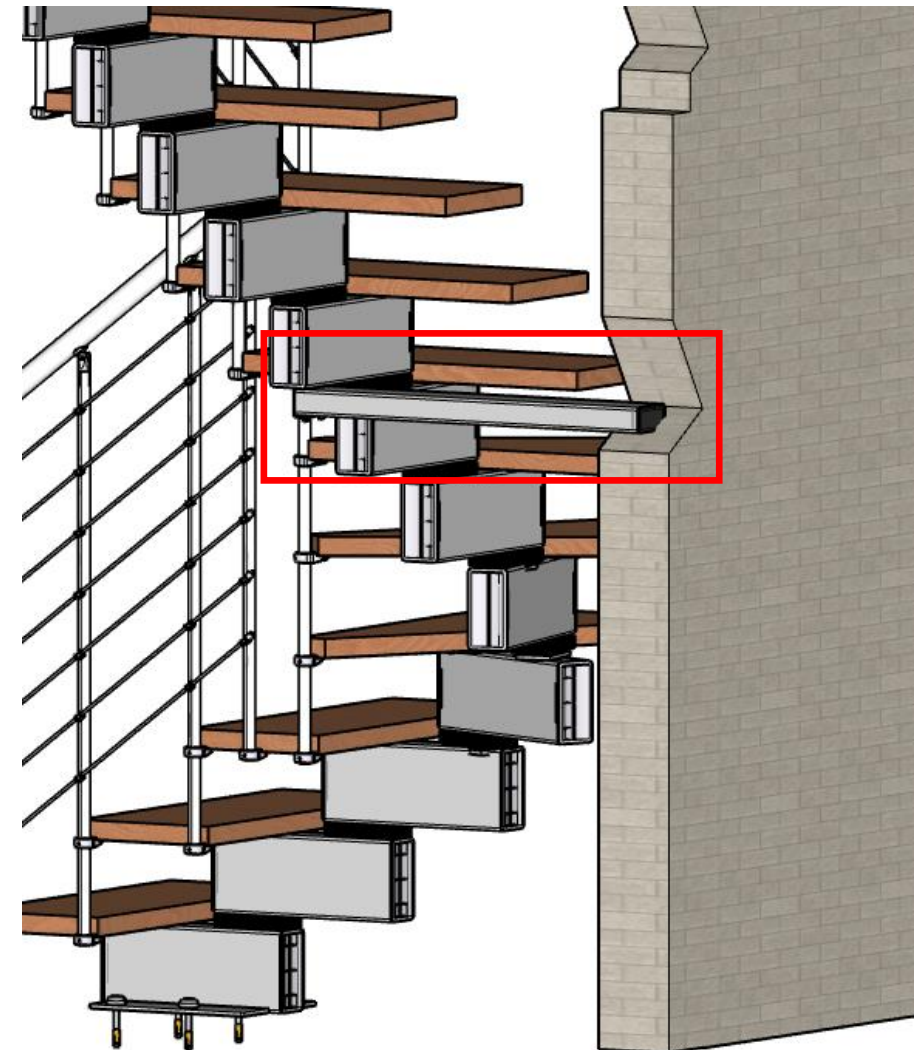



# VECTOR

Balaustra  
Balustrade – Balustrade  
Balustrade - Balaustrada

100 Kg/m

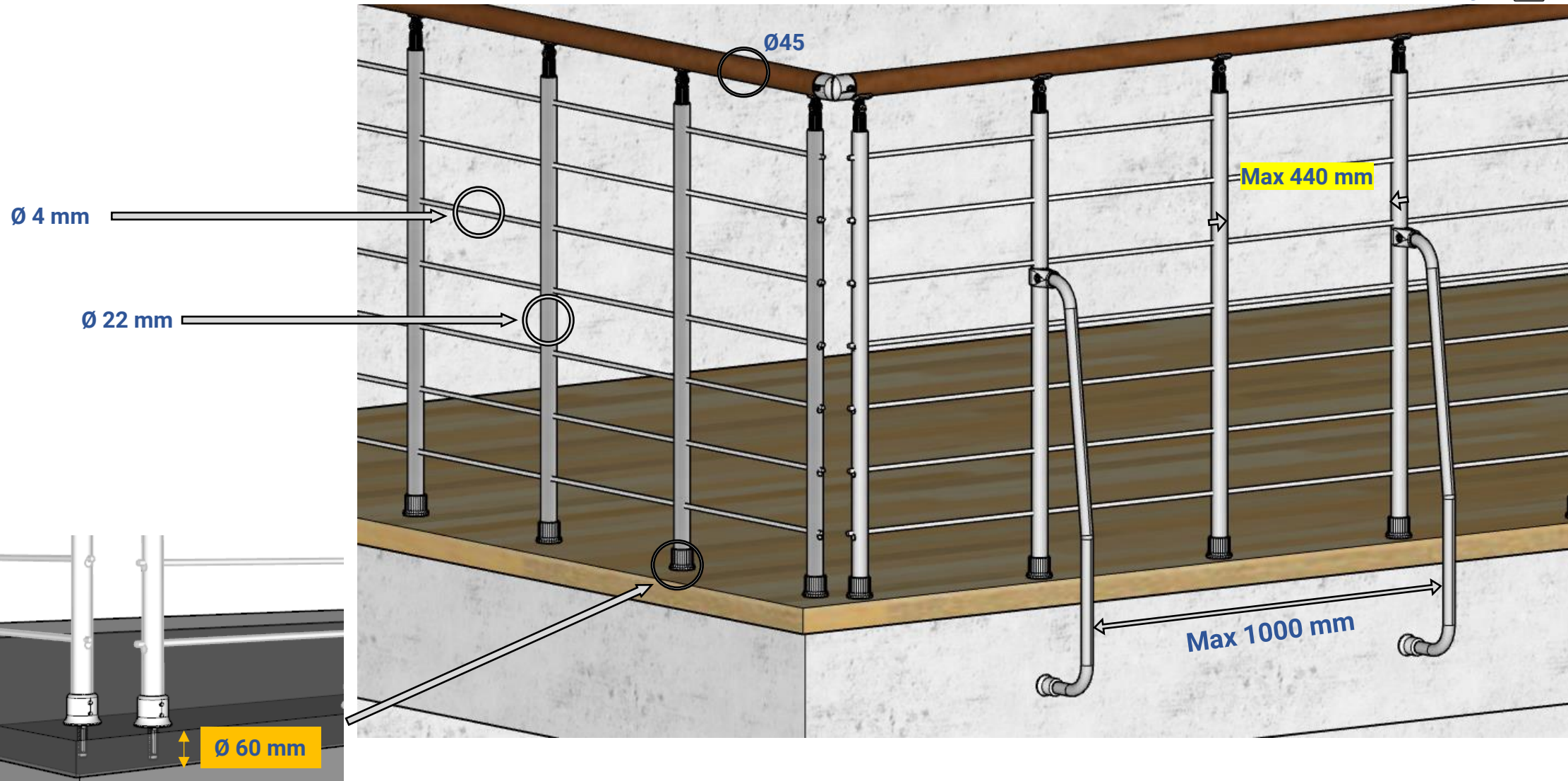

### Corrimano a muro

Wall handrail – Main courante murale  
Wandhandlauf – Pasamanos de pared



### Seconda ringhiera

Second handrail – Deuxième courante  
Sekundehandlauf – Segundo pasamanos

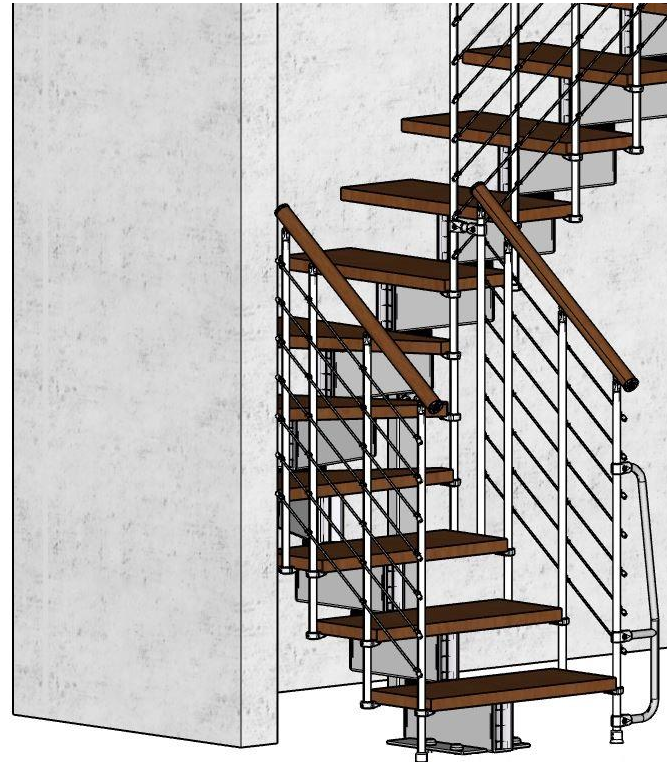

### Riser bar

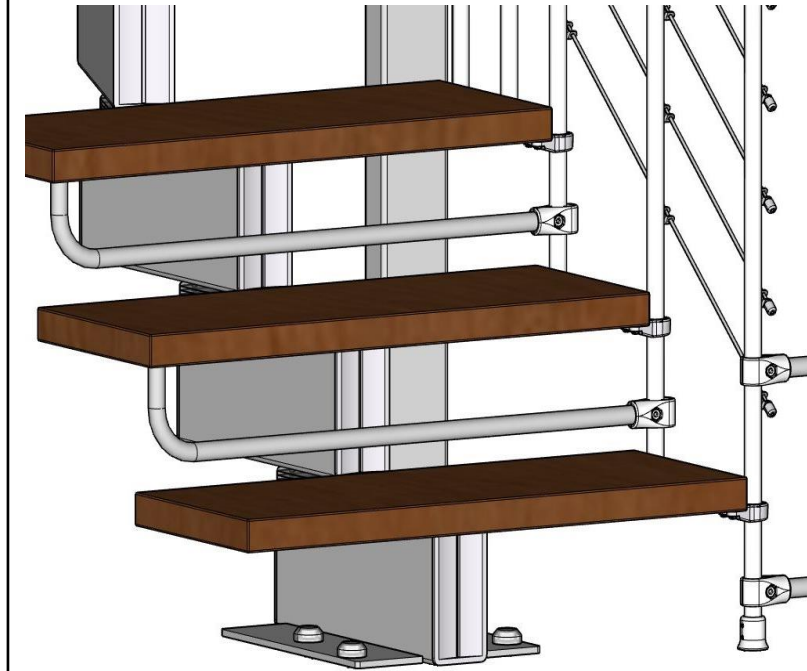

## Legno

Wood - Bois  
Holz - Madera



252 Noce medio  
Light chestnut  
Noyer moyen  
Nussbaumholz  
Nogal medio



**Faggio**  
Beech  
Hêtre  
Buche  
Haya



253 Naturale  
Natural  
Naturbuchenholz  
Couleur naturelle  
Natural

## Metallo

Metal - Métal  
Metall - Metal



90 RG



97 RG

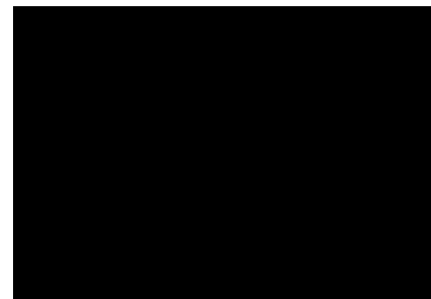

95 RG

## Componenti termoplastici

Thermoplastic components  
Composants thermoplastiques  
Thermoplastische Bauteile  
Componentes termoplásticos

