

REXAL MONO UP



UNI EN ISO 9001:2008



RICHEDE I PRODOTTI CERTIFICATI FSC



MADE IN ITALY

REXAL MONO UP

REXAL MONO UP

PIANTA

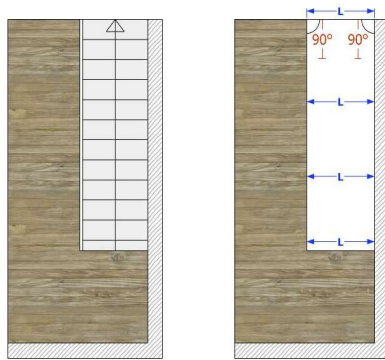

PROSPETTO

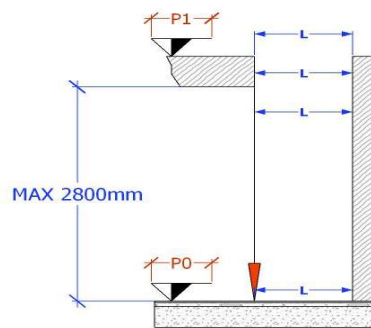

A soletta interna al foro
To the inner slab to the hole
A' semelle intérieure du trou

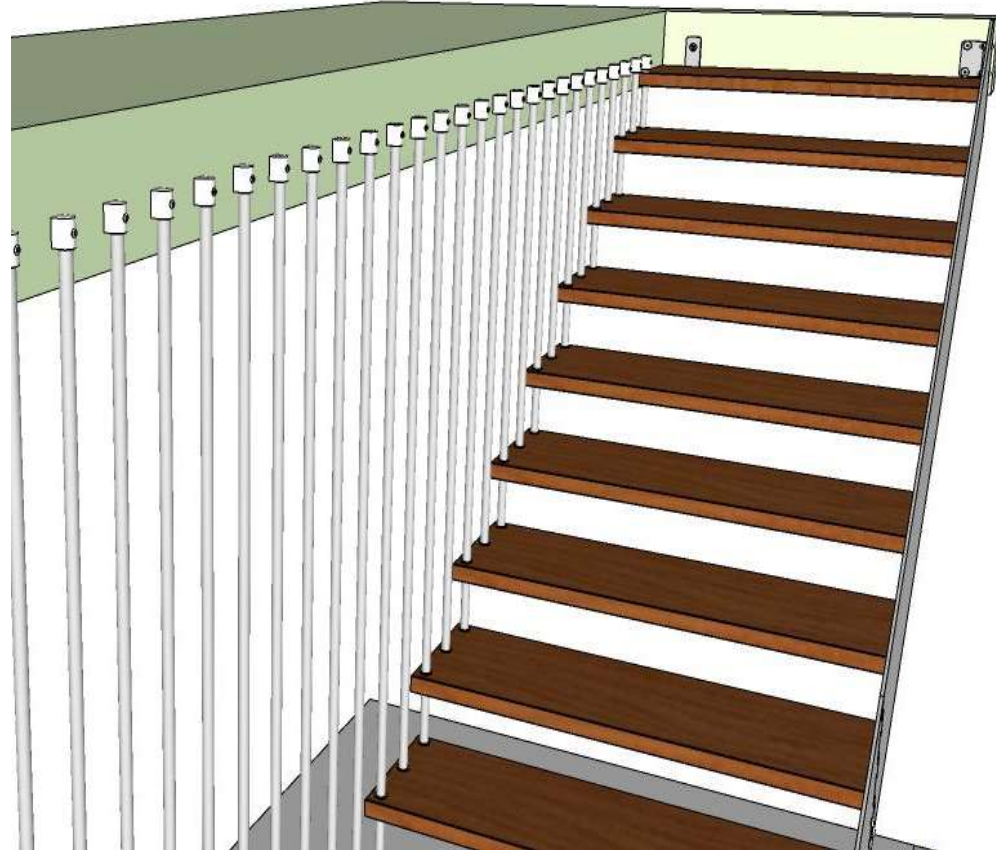

REXAL MONO UP

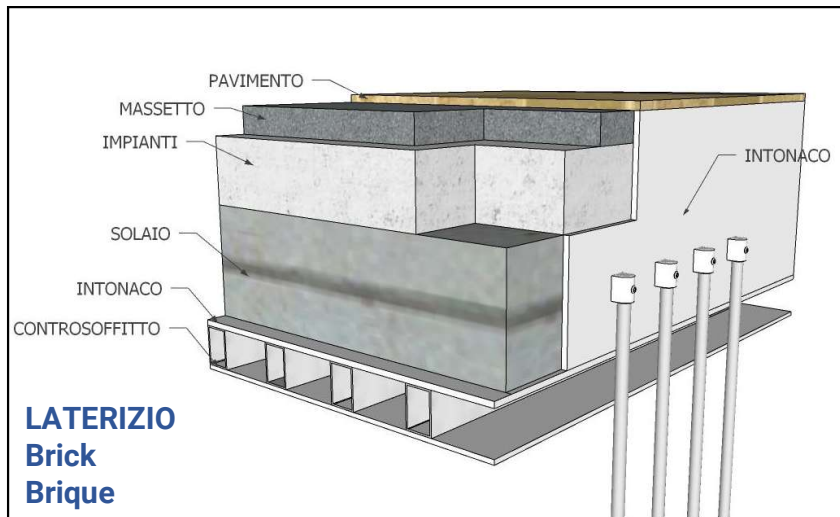

LATERIZIO
Brick
Brique

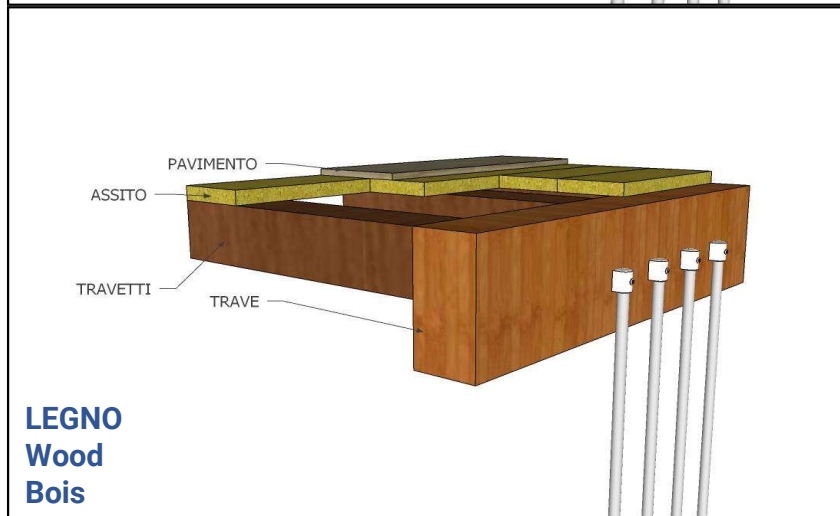

LEGNO
Wood
Bois

Tipologie di solai e di fissaggi
Types of slabs and fixings
Types de dalles et de fixations

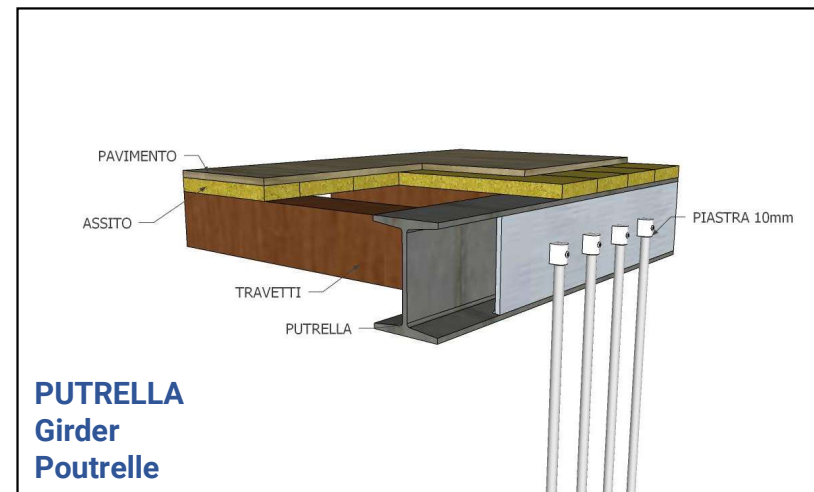

PUTRELLA
Girder
Poutrelle

REXAL MONO UP

REXAL MONO UP

PIANTA

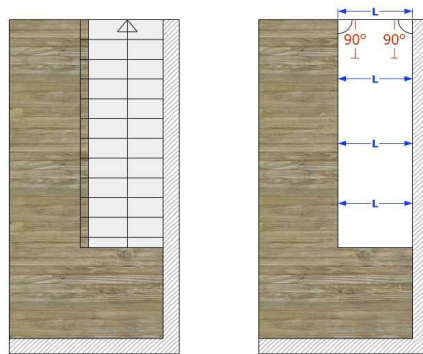

PROSPETTO

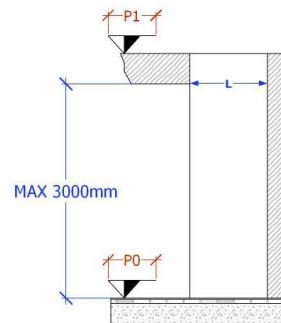

A soffitto con binario esterno foro
Ceiling with external rail hole
Plafond avec rail extérieur trou

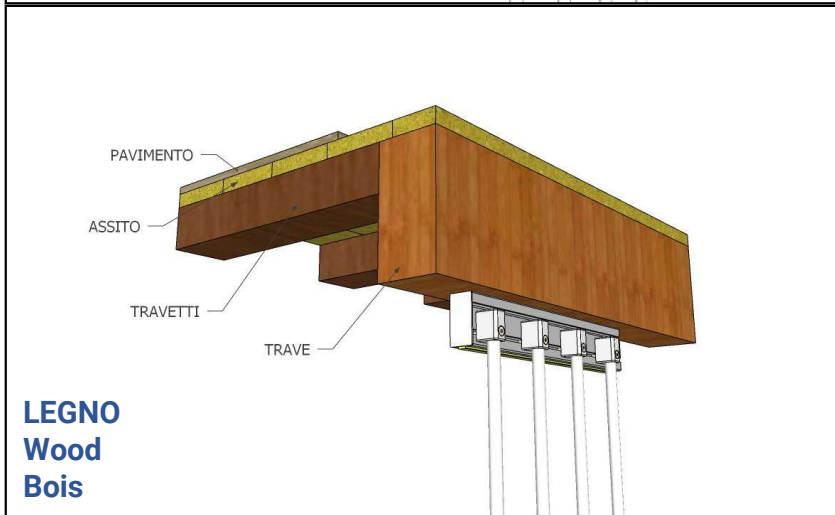
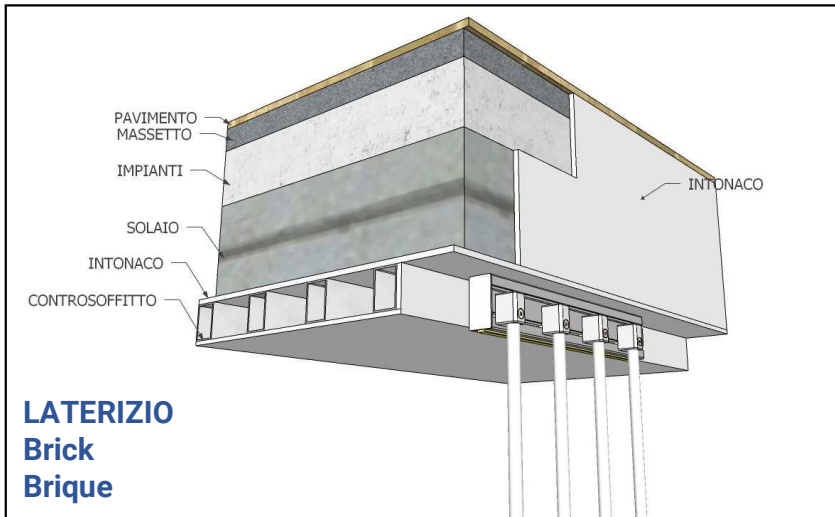

REXAL MONO UP

Tipologie di solai e di fissaggi
Types of slabs and fixings
Types de dalles et de fixations

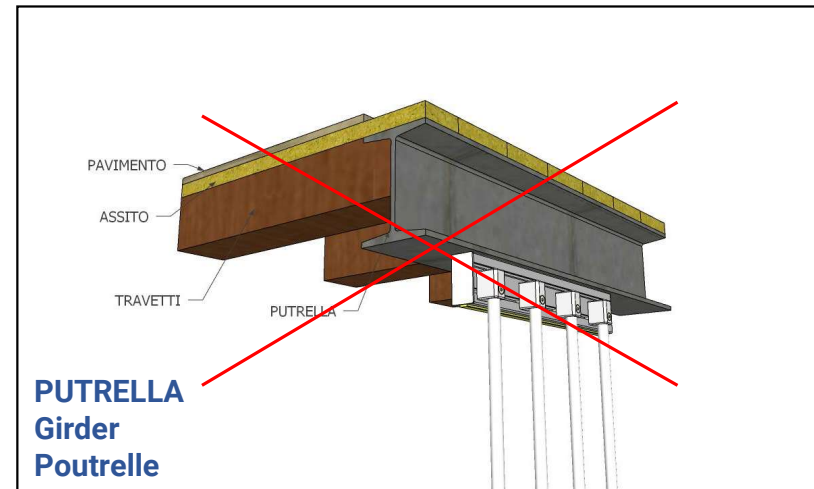

REXAL MONO UP

OPTIONAL



Corrimano a muro

Wall handrail
Main courante murale
Wandhandlauf
Pasamanos de pared



Angolo per pilastro (max 3 gradini)

Corner for Pillar (max 3 steps)
Angle pour Poteau (max 3 marches)
Winkel pro Säule (Max 3 Sufen)
Angulo por pilar (máximo 3 escalones)

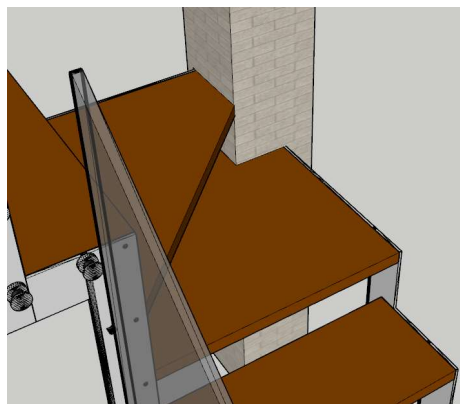

Soglia
Threshold
Seuil
Schwellenwert
Umbral

